

# Operating Instructions

CD CDV LD PLAYER

# CLD-1030

NTSC

COMPACT  
**disc**  
DIGITAL AUDIO



LaserVision

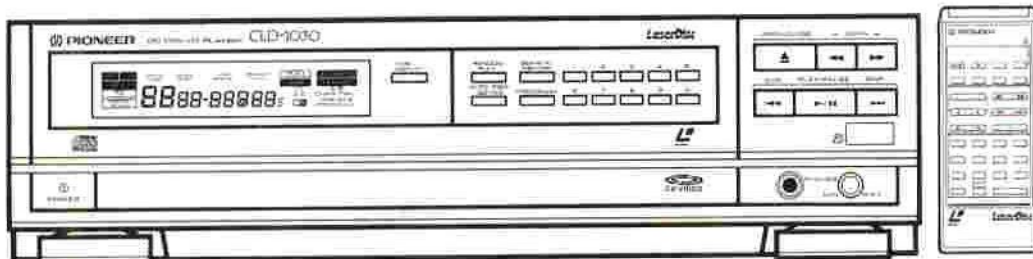

Thank you for buying this Pioneer product. Please read through these operating instructions so you will know how to operate your model properly. After you have finished reading the instructions, put them away in a safe place for future reference. In some countries or regions, the shape of the power plug and power outlet may sometimes differ from that shown in the explanatory drawings. However, the method of connecting and operating the unit is the same.

**WARNING:** TO PREVENT FIRE OR SHOCK HAZARD, DO NOT EXPOSE THIS APPLIANCE TO RAIN OR MOISTURE.

## IMPORTANT NOTICE [For U.S. and Canadian models]

The serial number for this equipment is located on the rear panel. Please write this serial number on your enclosed warranty card and keep it in a secure area. This is for your security.

## [For Canadian model]

**CAUTION:** TO PREVENT ELECTRIC SHOCK DO NOT USE THIS (POLARIZED) PLUG WITH AN EXTENSION CORD, RECEPTACLE OR OTHER OUTLET UNLESS THE BLADES CAN BE FULLY INSERTED TO PREVENT BLADE EXPOSURE.

**ATTENTION:** POUR PREVENIR LES CHOCS ELECTRIQUES NE PAS UTILISER CETTE FICHE POLARISEE AVEC UN PROLONGATEUR UNE PRISE DE COURANT OU UNE AUTRE SORTIE DE COURANT, SAUF SI LES LAMES PEUVENT ETRE INSEREES A FOND SANS EN LAISSER AUCUNE PARTIE A DECOUVERT.

# IMPORTANT



The lightning flash with arrowhead, within an equilateral triangle, is intended to alert the user of the presence of uninsulated "dangerous voltage" within the product's enclosure that may be of sufficient magnitude to constitute a risk of electric shock to persons.

**CAUTION**  
RISK OF ELECTRIC SHOCK  
DO NOT OPEN

**CAUTION:**  
TO PREVENT THE RISK OF ELECTRIC SHOCK, DO NOT REMOVE COVER (OR BACK). NO USER-SERVICEABLE PARTS INSIDE. REFER SERVICING TO QUALIFIED SERVICE PERSONNEL.



The exclamation point within an equilateral triangle is intended to alert the user of the presence of important operating and maintenance (servicing) instructions in the literature accompanying the appliance.

## SAFETY INSTRUCTIONS

**READ INSTRUCTIONS** — All the safety and operating instructions should be read before the appliance is operated.

**RETAIN INSTRUCTIONS** — The safety and operating instructions should be retained for future reference.

**HEED WARNINGS** — All warnings on the appliance and in the operating instructions should be adhered to.

**FOLLOW INSTRUCTIONS** — All operating and use instructions should be followed.

**CLEANING** — Unplug this video product from the wall outlet before cleaning. Do not use liquid cleaners or aerosol cleaners. Use a damp cloth for cleaning.

**ATTACHMENTS** — Do not use attachments not recommended by the video product manufacturer as they may cause hazards.

**WATER AND MOISTURE** — Do not use this video product near water — for example, near a bathtub, wash bowl, kitchen sink, or laundry tub, in a wet basement, or near a swimming pool, and the like.

**ACCESSORIES** — Do not place this video product on an unstable cart, stand, tripod, bracket, or table. The video product may fall, causing serious injury to a child or adult, and serious damage to the appliance. Use only with a cart, stand, tripod, bracket, or table recommended by the manufacturer, or sold with the video product. Any mounting of the appliance should follow the manufacturer's instructions, and should use a mounting accessory recommended by the manufacturer.

**VENTILATION** — Slots and openings in the cabinet are provided for ventilation and to ensure reliable operation of the video product and to protect it from overheating, and these openings must not be blocked or covered. The openings should never be blocked by placing the video product on a bed, sofa, rug, or other similar surface. This video product should never be placed near or over a radiator or heat register. This video product should not be placed in a built-in installation such as a bookcase or rack unless proper ventilation is provided or the manufacturer's instructions have been adhered to.

**POWER SOURCES** — This video product should be operated only from the type of power source indicated on the marking label. If you are not sure of the type of power supply to your home, consult your appliance dealer or local power company. For video products intended to operate from battery power, or other sources, refer to the operating instructions.

**POLARIZATION** — This video product is equipped with a polarized alternating current line plug (a plug having one blade wider than the other). This plug will fit into the power outlet only one way. This is a safety feature. If you are unable to insert the plug fully into the outlet, try reversing the plug. If the plug should still fail to fit, contact your electrician to replace your obsolete outlet. Do not defeat the safety purpose of the polarized plug.

**POWER-CORD PROTECTION**  
Power-supply cords should be routed so that they are not likely to be walked on or pinched by items placed upon or against them, paying particular attention to cords at plugs, convenience receptacles, and the point where they exit from the appliance.

**LIGHTNING** — For added protection for this video product receiver during a lightning storm, or when it is left unattended and unused for long periods of time, unplug it from the wall outlet and disconnect the antenna or cable system. This will prevent damage to the video product due to lightning and power-line surges.

**POWER LINES** — An outside antenna system should not be located in the vicinity of overhead power lines or other electric light or power circuits, or where it can fall into such power lines or circuits. When installing an outside antenna system, extreme care should be taken to keep from touching such power lines or circuits as contact with them might be fatal.

**OVERLOADING** — Do not overload wall outlets and extension cords as this can result in the risk of fire or electric shock.

**OBJECT AND LIQUID ENTRY** — Never push objects of any kind into this video product through openings as they may touch dangerous voltage points or short-out parts that could result in a fire or electric shock. Never spill liquid of any kind on the video product.

**SERVICING** — Do not attempt to service this video product yourself as opening or removing covers may expose you to dangerous voltage or other hazards. Refer all servicing to qualified service personnel.

### DAMAGE REQUIRING SERVICE

Unplug this video product from the wall outlet and refer servicing to qualified service personnel under the following conditions:

- When the power-supply cord or plug is damaged.
- If liquid has been spilled, or objects have fallen into the video product.
- If the video product has been exposed to rain or water.
- If the video product does not operate normally by following the operating instructions. Adjust only those controls that are covered by the operating instructions as an improper adjustment of other controls may result in damage and will often require extensive work by a qualified technician to restore the video product to its normal operation.
- If the video product has been dropped or the cabinet has been damaged.
- When the video product exhibits a distinct change in performance — this indicates a need for service.

**REPLACEMENT PARTS** — When replacement parts are required, be sure the service technician has used replacement parts specified by the manufacturer or having the same characteristics as the original part. Unauthorized substitutions may result in fire, electric shock or other hazards.

**SAFETY CHECK** — Upon completion of any service or repairs to this video product, ask the service technician to perform safety checks to determine that the video product is in proper operating condition.

**OUTDOOR ANTENNA GROUNDING** — If an outside antenna is connected to the antenna terminal, be sure the antenna system is grounded so as to provide some protection against voltage surges and built-up static charges.

In the U.S.A. section 810 of the National Electrical Code, ANSI/NFPA No. 70-1984, provides information with respect to proper grounding of the mast and supporting structure, grounding of the lead-in wire to an antenna discharge unit, size of grounding conductors, location of antenna-discharge unit, connection to grounding electrodes, and requirements for the grounding electrode. See Fig. A.

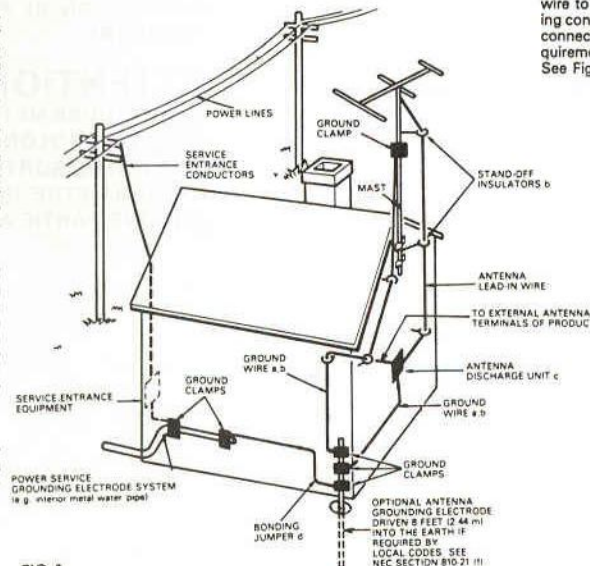

FIG. A

- Use No. 10 AWG (5.3 mm<sup>2</sup>) copper wire, No. 8 AWG (8.4 mm<sup>2</sup>) aluminum wire, No. 17 AWG (1.0 mm<sup>2</sup>) copper-clad steel wire, bronze wire or larger wire as ground wire.
- Secure antenna lead-in and ground wires to house with stand-off insulators spaced from 4 feet (1.22 meters) to 6 feet (1.83 meters) apart.
- Mount antenna discharge unit as closely as possible to where lead-in enters house.
- Use jumper wire not smaller than No. 6 AWG (13.3 mm<sup>2</sup>) copper, or the equivalent, when a separate antenna-grounding electrode is used. See NEC Section 810-21 (1).

# CONTENTS

Features .....	4	Basic Operation .....	18
Precautions .....	6	Remote Control Operations .....	21
LaserVision Videodiscs .....	7	LaserVision Disc Playback Functions .....	22
Compact Discs with Video (CDV) .....	7	Compact Disc Playback Functions .....	28
Rear Panel Facilities .....	9	Repeat Playback .....	34
Connections .....	10	Program Playback .....	38
Panel and Remote Control Unit Facilities .....	13	Troubleshooting .....	41
		Specifications .....	45

## [FOR U.S. MODEL]

### CAUTION

- Use of controls or adjustments or performance of procedures other than those specified herein may result in hazardous radiation exposure.
- The use of optical instruments with this product will increase eye hazard.

### Note to CATV system installer

This reminder is provided to call the CATV system installer's attention to Article 820-22 of the NEC that provides guidelines for proper grounding and, in particular, specifies that the cable ground shall be connected to the grounding system of the building, as close to the point of cable entry as practical.

- This player may be used with LaserVision Discs, Compact Discs, and Compact Discs with Video bearing the following symbols:

#### (LaserVision Disc)



LaserVision

This is the unified symbol mark of LaserVision videodisc

- LaserVision players and discs which bear this symbol and use the same television system, are mutually compatible.

#### (Compact Disc)



#### (Compact Disc with Video)



This player is to be used exclusively with the NTSC color system. Please use NTSC LaserVision Disc or NTSC Compact Disc with Video only. PAL and SECAM system discs cannot be used with this player.

# FEATURES

## AUTO LOADING FUNCTION WITH AUTOMATIC DISCRIMINATION

The disc table is automatically opened and closed by the motor drive, so mounting and removing discs is simple. When the disc table is pulled into the player, the player automatically senses the disc type and starts to play.

## LARGE EASY-TO-READ DISPLAY

A large easy-to-read display on the front panel displays the chapter, track, frame, time and the repeat modes. This allows you to check the playback status and the present playing location on the disc.

## EXTERNAL CONTROL

The player is provided with control input/output terminals. These enable it to be controlled by or connected into systems comprising products with the PIONEER  mark.

## MULTI-FUNCTIONAL WIRELESS REMOTE CONTROL

The accompanying remote control unit enables you to operate this player from a distance.



This remote control has keys for the most common operations, play, fast forward, and fast reverse, in the center and operation keys grouped by operation for setting the state of the player, special playback, search, and programming, etc. to make the player easier to operate with the remote control.

## DIGITAL FILTER

A digital filter is used in the audio circuits to eliminate the need for a high-order low-pass filter. This produces audio characteristics with a low distortion ratio and low phase drift up to the 20kHz region.

## DISCS

LaserVision Discs (LD), Compact Discs with Video (CDV) and Compact Discs (CD) have the following characteristics.

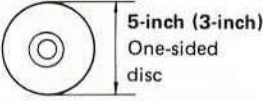
		LD	CDV	CD
Disc shape		 12-inch (8-inch) Double-sided or one-sided discs	 5-inch One-sided disc	 5-inch (3-inch) One-sided disc
Color		Silver	Gold	Silver
Recorded material	Audio only	X	20 min., Digital	5-inch: More than 60 min., Digital 3-inch: More than 20 min., Digital
	Audio + video	Video	5 min. (CLV)	X
	Audio	Digital	○	○
Analog		○	X	—
Disc rotation speed		CLV 1800 ~ 600 rpm CAV 1800 rpm	Audio portion (Inner circumference) 600 ~ 340 rpm Video + Audio portion (Outer circumference) 2700 ~ 1800 rpm	600 ~ 200 rpm

## CONFIRMATION OF ACCESSORIES

THE FOLLOWING ACCESSORIES ARE SUPPLIED WITH THIS PLAYER.

- Remote control unit
- Size "AAA" (IEC R03) dry battery x 2

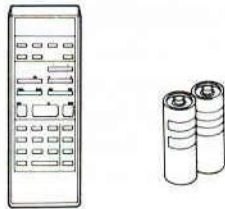

- Antenna adaptor (75  $\Omega$ /300  $\Omega$   $\rightarrow$  75  $\Omega$ F)  
Use to connect a VHF antenna cable to the antenna terminal of the player.

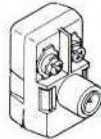

- Audio connecting cord (Pin plug x 2  $\leftrightarrow$  Pin plug x 2)  
Use to connect the player to a stereo amplifier etc.



- Video connecting cord (Pin plug  $\leftrightarrow$  Pin plug)  
Use to connect the player to a color monitor etc.



- RF antenna cable (J-type plug  $\leftrightarrow$  J-type plug)  
Use to connect the player to a TV set.



- Operating instructions
- Warranty card

## PUTTING BATTERIES INTO THE REMOTE CONTROL UNIT

1. Open the battery compartment cover on the rear of the remote control unit. The cover should open easily if you press on it with your thumb while sliding it in the direction of the arrow.
2. Take out the two accessory size "AAA" (IEC R03) dry batteries, and insert them into the battery compartment in accordance with the indications in the compartment.
3. Close the cover of the battery case.

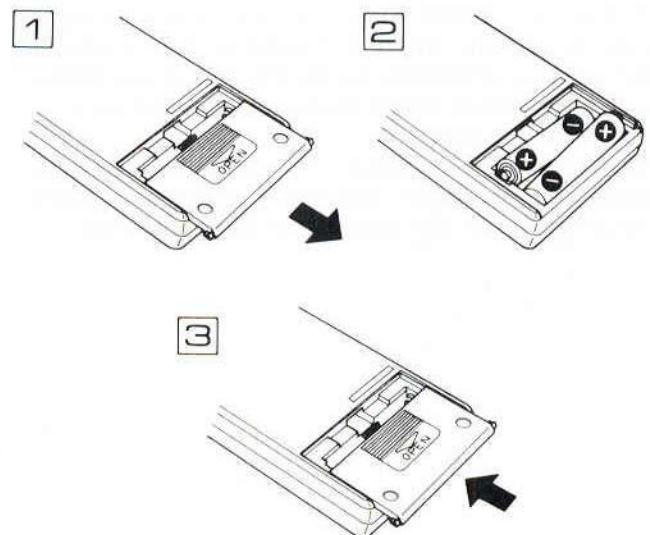

Incorrect use of batteries may lead to leakage or rupture. Always be sure to follow these guidelines:

- A. Always insert batteries into the battery compartment correctly matching the positive (+) and negative (-) polarities, as shown by the display inside the compartment.
- B. Never mix new and used batteries.
- C. Batteries of the same size may have differing voltages, depending on brand. Do not mix different brands of batteries.
- D. Both rechargeable and non-rechargeable batteries are available. Be sure to use your batteries in accordance with the caution labels affixed to them.

# PRECAUTIONS

## INSTALLING THE PLAYER

- Choose a stable platform next to the television and stereo system with which you plan to use the player.
- When using the player with a stereo system, your speakers should be installed somewhat separated from your television (or TV monitor).
- Do not place heavy objects such as your television or TV monitor on top of the player.
- Do not place the player on top of your TV set or TV monitor. Also, keep the player away from devices such as cassettes decks which are sensitive to magnetic fields.

When FM or AM stations are being received, signal noise may be generated if the player is turned on. Turn off the player when not in use. Also, if there is signal noise when receiving radio stations with an indoor antenna, adjust the position or direction of the antenna.

## INSTALL THE PLAYER IN A WELL VENTILATED PLACE AWAY FROM HEAT AND HUMIDITY

Do not install the player in a location subject to direct sunlight, or near a stove or radiator etc. This could adversely affect the cabinet and internal components. Also avoid installing the player in a humid or dusty location. This could result in a malfunction or accident. Do not install near cooking ranges where the player could be affected by smoke, steam, or heat.

## AVOID SOURCES OF HEAT

Do not put the player on sources of heat, such as an amplifier. When installing with audio components on a rack, avoid components that generate heat such as amplifiers, by placing the player below such components where there is adequate ventilation with little dust.

Avoid placing the player on surfaces such as shaggy carpets, beds, and sofas which may block ventilation under the player and cause damage.

## CAUTIONS FOR AUTOMATIC LOADING OPERATIONS

Since this player has an automatic loading construction, use the key on the player or the remote control key for removal and insertion of the disc table. To avoid damage, be careful not to apply any force to the moving disc table.

## STRIPE PATTERNS APPEARING ON A TV PROGRAM

Stripe patterns may appear during a TV program if the power for the player unit is turned on, depending on the quality of reception of the TV station. This is neither a malfunction of the television or the player. If stripes appear while watching the TV, or when watching the TV for long periods of time, turn the power for the player off.



## CONDENSATION

Moisture will form in the operating section of the player and the player's performance will be impaired if the player is brought from cool surroundings into a warm room or if the temperature of the room rises suddenly.

To prevent this, let the player stand in its new surroundings for about an hour before switching it on, or ensure that the room temperature rises gradually.

The same symptoms of condensation may be caused during summer, if the player is exposed to the breeze from an air conditioner. In such cases change the location of the player.

## CLEANING CARE

Use a soft, dry cloth for cleaning. For stubborn dirt, rinse the cloth in a weak detergent solution, wring well, then wipe. Use a dry cloth to wipe it dry. Do not use any volatile agents such as benzene and paint thinner, as it may damage the surface of the player.

# LASERVISION VIDEODISCS

The CLD-1030 can play both LaserVision Discs and Compact Discs. Unlike conventional phonograph records, these discs are played back from the inside edge out.

LaserVision Discs are available as both standard play discs and extended play discs. Discs with digitally recorded sound are also available.

## STANDARD PLAY (CAV) DISC

Standard play discs are played at constant angular velocity (CAV). Still-frame and other forms of trick playback are possible with these discs.

## EXTENDED PLAY (CLV) DISCS

These discs are played back at constant linear velocity (CLV), and are therefore able to play for a longer length of time than standard play discs. Extended play discs cannot be used for trick playback, but random access and repeat playback etc. are possible.

## LASERVISION WITH DIGITAL SOUND DISCS



The jackets and labels of these discs bear the symbol on the left.

In addition to conventional analog sound signals, LaserVision with Digital Sound Discs also have recorded on them the same kind of PCM sound signals that are recorded on Compact Discs.

With these discs, the high quality pictures of LaserVision Discs and digital sound, can be enjoyed at the same time.

The two types of sound, digital and analog, are recorded onto the discs using different frequency bands.

# COMPACT DISCS WITH VIDEO (CDV)

Compact Discs with Video (CDV) are colored gold to distinguish them from conventional Compact Discs. These discs have an audio sound portion on the inner circumference which lasts 20 minutes, and a 5-minute video portion with digital audio on the outer circumference. The video portion is recorded at a fixed linear speed in the same manner as an extended play LaserVision Disc (CLV). The audio portion also features entirely digital audio.

\* Disc playing time varies depending on what is recorded on the respective disc.

## LASERVISION WITH DIGITAL SOUND WITH MULTI AUDIO DISC



The jackets and labels of these discs bear the symbol on the left.

Digital audio and analog audio feature different audio reproduction characteristics and the two types can be switched back and forth freely for increased enjoyment of both digital and analog audio.

Audio applications

Disc \ Audio	Analog audio	Digital audio
Movies, Animations, etc.	Audio of the main program (Program compilation)	Sound track (Music compilation)
Dual music	Music 1	Music 2
Stereo multi kara-oke	Kara-oke	Vocal backup
Stereo bilingual broadcasting	English	Spanish
Tri-lingual	English	D1/L Spanish D2/R German
Quad-lingual	A1/L English A2/R Spanish	D1/L German D2/R French

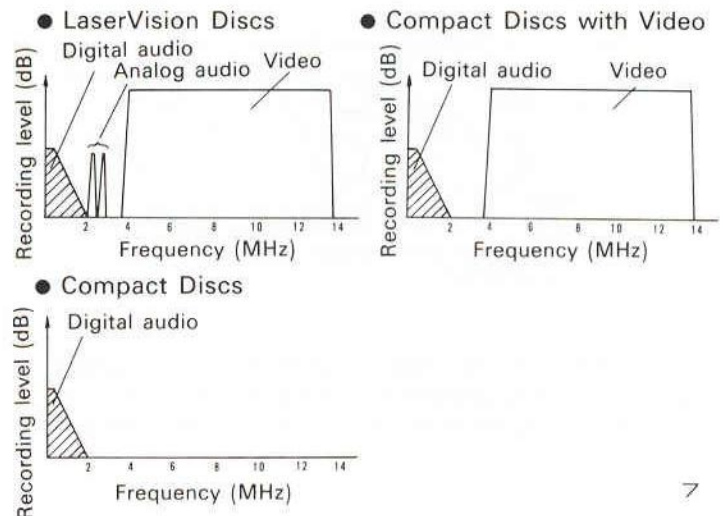

### CARE OF DISCS

#### How to hold discs

When loading or removing discs, try not to touch their playing surfaces.

#### How to hold the LaserVision Disc

**Holding with both hands...** Hold the disc by its edges with both hands, as shown in Fig. A.

**Holding with one hand...** As shown in Fig. B, hold the disc by its center hole and one edge.

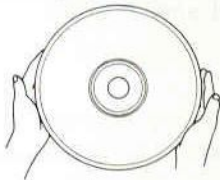

Fig. A

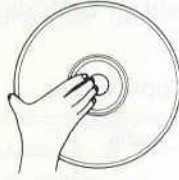

Fig. B

#### How to hold the Compact Disc

Hold the disc by its edges as shown in Fig. C

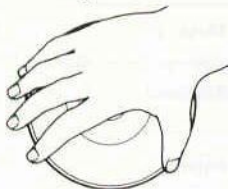
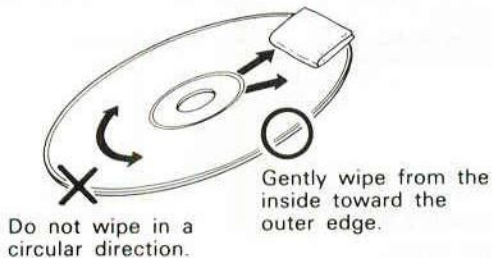

Fig. C

### Cleaning

The presence of fingerprints or other dirt etc. on the disc, will not directly affect the recorded signal. Nevertheless, dirt on the disc will cause the brightness of the light reflected from the signal surface to be reduced, which may adversely affect sound and picture quality. If a disc is dirty, clean the disc before playing it.

To clean your discs, use a soft clean cloth to wipe them. If necessary, moisten a soft cloth with diluted neutral detergent to remove heavy dirt or fingerprints.



Discs may not be cleaned with record cleaning sprays, or static prevention sprays etc. Also do not use volatile liquids such as benzene, or thinner etc.

### Do not use damaged discs

Do not use damaged discs that are warped or cracked etc. This may result in damage to the player.

### After using discs, store them vertically upright

After playing a disc, always remove it from the player and return it to its jacket. Then store it standing vertically upright away from heat and humidity.

- Take care when storing discs. If you store discs at an angle, or stacked on top of each other, discs may become warped even when in their jackets.
- Do not leave discs in locations such as the seat of car, which may become unbelievable hot.

If a disc is warped, put the disc into its protective envelope, and then place it between two flat plates of glass. Then place heavy books on top of the plates so that approximately 4 to 5 kg are applied. Leave the disc like this for a day or so. This may correct the warp.

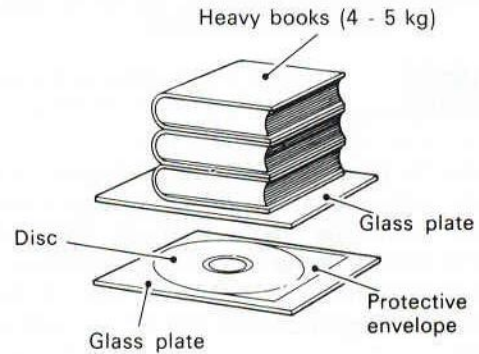

### CAUTION WHEN USING THE DISC

All rights reserved.

Unauthorized public performance, broadcasting or copying is a violation of applicable laws.



# REAR PANEL FACILITIES

## ANTENNA terminal (75 Ω F-type jack)

Connect the coaxial cable (75 Ω) from the VHF TV antenna to this terminal.

## VHF OUT terminal (75 Ω F-type jack)

Connect this terminal to your TV set's VHF antenna terminal.

## VHF CHANNEL SELECTOR (CH3/CH4)

This switch is for changing the channel of the internal VHF converter.

Set to the channel which is not used for TV broadcasts in your area.

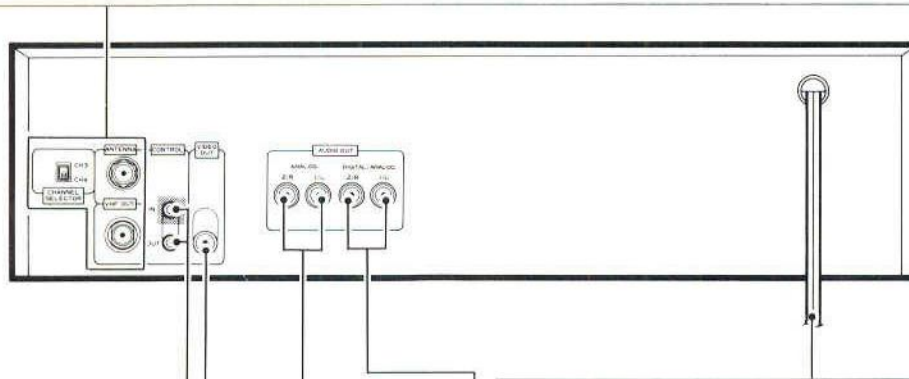

## CONTROL IN and OUT terminals (miniature phone jack)

These terminals are for control cords, when the player is used together with other Pioneer products with the Pioneer  mark.

## VIDEO OUT terminal (RCA jack)

Connect this jack to a TV monitor or a TV set which is equipped with a video input terminal.

## ANALOG AUDIO OUT terminals (RCA jacks)

These terminals output the analog audio of LaserVision Discs only. Connect them to the AUX input terminals of your stereo amplifier.

Do not connect these terminals to your amplifier PHONO input.

These terminals do not output the digital sound from Compact Discs, Compact Discs with Video or LaserVision with Digital Sound Discs.

## DIGITAL/ANALOG AUDIO OUT terminals (RCA jacks)

These terminals output Compact Disc audio, Compact Disc with Video audio, LaserVision Disc audio (analog) and the audio for LaserVision with Digital Sound Discs. Selection of either digital or analog sound can be made by operating a button on the remote control unit.

Connect these terminals to the CD or AUX input terminals etc. of your stereo amplifier.

Do not connect them to your amplifier PHONO input.



## Power cord

Connect this to a power outlet.

## ABOUT THE AUDIO OUTPUT TERMINALS

This player is equipped with two sets of audio output terminals.

As shown in the table below, the DIGITAL/ANALOG terminals are able to output all the audio signals that can be played back by the player.

Type of Disc	Playback Sound	Output Terminals
Compact Disc	Digital	DIGITAL/ANALOG
LaserVision with Digital Sound Discs (Discs with the  mark)	Digital	DIGITAL/ANALOG
	Analog	DIGITAL/ANALOG
LaserVision Discs (Discs without the  mark)	Analog	DIGITAL/ANALOG ANALOG

Can be selected with the AUTO DIGITAL/ANALOG key on the remote control unit

## For ordinary operation, connect the DIGITAL/ANALOG terminals to your amplifier.

The ANALOG terminals are provided for developmental use. They do not need to be used for ordinary operation.

For details regarding selection of either digital sound or analog sound when playing back LaserVision with Digital Sound Discs, please refer to page 22 "AUDIO REPRODUCTION".

# CONNECTIONS

## BASIC COMBINATION

CLD-1030 + TV set + Stereo system + (VCR)

When making connections, switch off power to the player and other units to be connected, and remove the plugs of each unit from the power outlets. Switch on power after connections have been made.

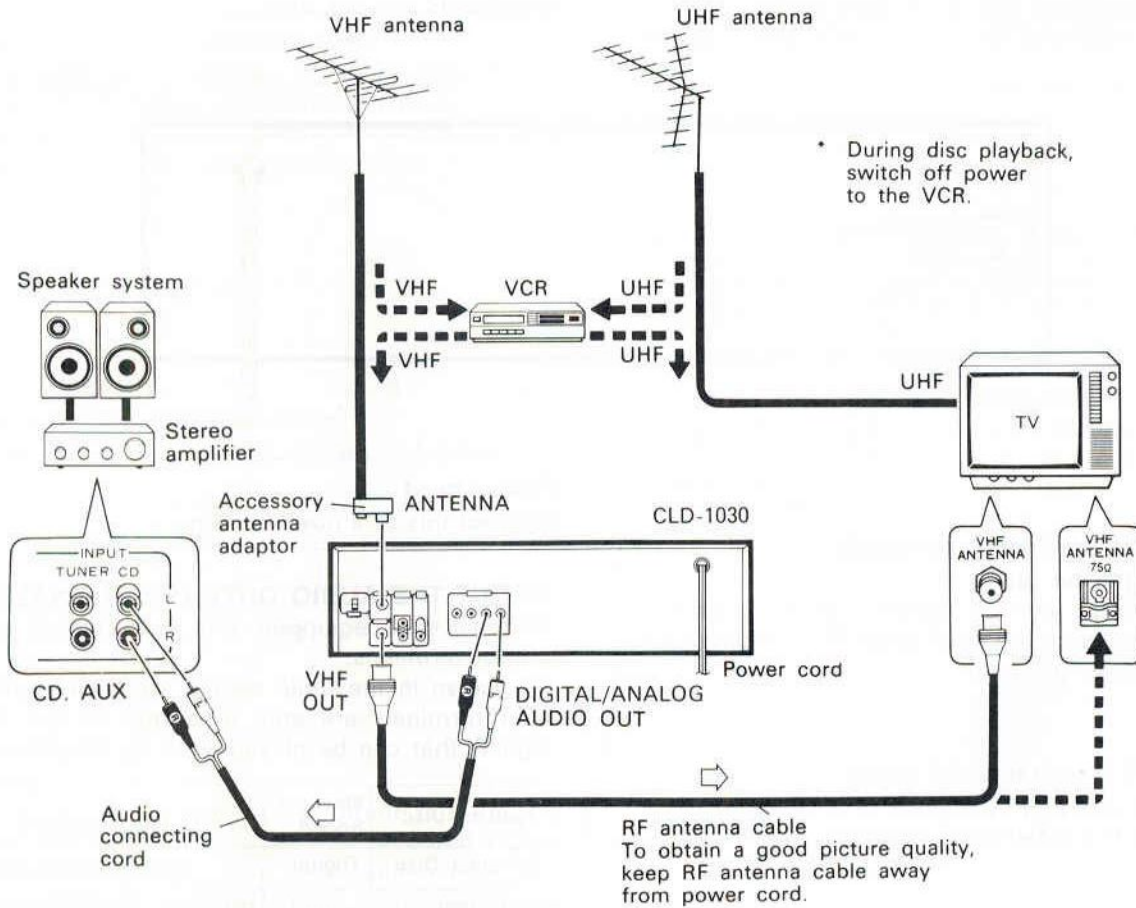

### 1. VHF TV ANTENNA CONNECTION

Detach the VHF antenna cable from the VHF antenna terminal of your TV set, and connect the cable to the ANTERNA terminal on the player.

If the end of the cable does not match the ANTERNA terminal, attach the accessory antenna adaptor, and plug the adaptor into the ANTERNA terminal.

#### Attach the antenna adaptor

**<For 75 Ω coaxial cable>**

- Strip off the end of the cable as shown below.
- Remove the cover.
 

Press both sides at the same time.
- Remove the ring. (To convert it into a 75Ω adapter.)
- Connect the cable as shown below.
 

Use a screwdriver.
- Put the cover back on.

Place the removed ring on the ringholder on the cover.

**<For 300 Ω parallel feeder>**

- Strip off the insulation of the feeder wire as shown below.
- Connect the wire to the 300Ω terminal.
 

Loosen the screws, twine the wire around and tighten the screws.

## 2. CONNECTING TO YOUR TV SET

Connect the VHF OUT terminal of the player to the 75  $\Omega$  VHF antenna terminal of your TV set with the accessory RF antenna cable. If the VHF antenna terminal of your TV set is not an F type terminal, modify one end of the cable.

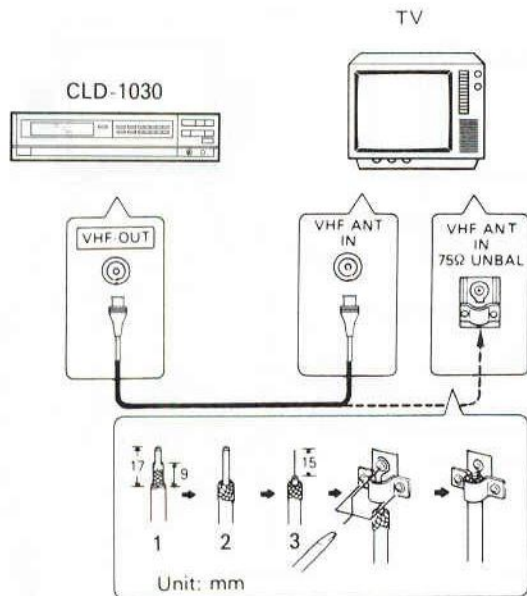

### 75 $\Omega$ coaxial cable preparation

1. Strip the end of the cable as shown in step 1.
2. Prepare the end as shown in steps 2 and 3.
3. Loosen the three screws and insert the cable.
4. Tighten the three screws firmly.

#### NOTE:

- Push the plug in firmly. If the plug is not properly pushed in, this may result in snow on the screen or noise.
- The shape of the VHF antenna input terminal and the method of connecting the antenna cable may differ from one TV set to another. For details, please refer to your TV instruction manual.

## 3. SET THE CHANNEL SELECTOR SWITCH

If channel 3 is not being used for broadcasts in your area, set the channel selector switch to channel 3. If channel 4 is not being used, set the switch to channel 4. The setting you choose will be the disc playback channel.

## 4. CONNECTING TO YOUR STEREO AMPLIFIER

Connect the DIGITAL/ANALOG audio output terminals of the player to the AUX or CD input terminals of your stereo amplifier.

#### NOTE:

- Do not connect these terminals to your amplifier PHONO input terminals.
- The ANALOG audio output terminals do not output the digital sound from Compact Discs, Compact Discs with Video or LaserVision with Digital Sound Discs.

## 5. PLUG THE POWER CORDS INTO AC OUTLET

Plug the AC power cords of the player, stereo amplifier and TV set into an AC outlet.

### WHEN USING A TV MONITOR (OR A TV SET WITH VIDEO AND AUDIO INPUT TERMINALS)

Connect the VIDEO OUT terminal of the player to the video input terminal of the TV monitor (or TV set). Connect the DIGITAL/ANALOG audio output terminals of the player to the audio input terminals.

### WHEN NOT USING A STEREO AMPLIFIER

If the unit is used in a basic system without a stereo amplifier and only with a television set, the television sound may not be output. In such a case, set the stereo amplifier's selector for the component connected to the amplifier's input (in the example figure, "CD"). Depending on the type of stereo amplifier, sound may still not be output. In such a case, have the stereo amplifier output the sound.

**WHEN COMBINED WITH OPTIONAL PIONEER PROJECTION MONITOR (or COMPONENT DISPLAY):**

Connect the VIDEO OUT terminal of the player to the video input terminal of the projection monitor (or component display), and connect the DIGITAL/ANALOG audio output terminals of the player to the audio input terminals of the projection monitor (or component display).

**(System Control)**

By connecting the control input terminal of the player to the remote terminal of the projection monitor (or component display), the system can be controlled by aiming the remote control unit of the player at the remote control receiver of the projection monitor (or component display).

- To use the CONTROL IN terminal, make use of a miniature phone plug cord.

Please also refer to the operating instructions for the projection monitor (or component display).

**NOTE:**

When system control connections have been made, the player can not be directly controlled by the remote control unit. To operate the player, aim the remote control unit at the projection monitor (or component display).

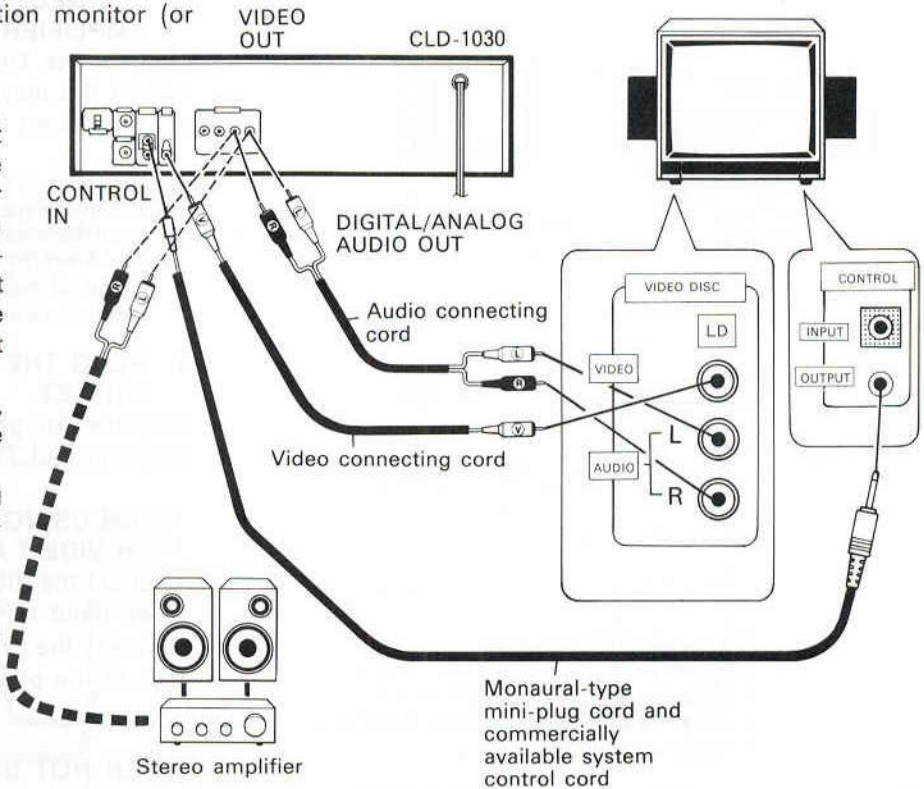

**CARRYING OUT SYSTEM CONTROL WHEN THE PLAYER IS COMBINED WITH A PRODUCT WITH THE PIONEER SR MARK:**

When the player is combined with an AV receiver or AV master amplifier (optional), which can provide centralized control of Pioneer products with the SR mark, system control can be carried out.

Connect the VIDEO OUT terminal of the player to the video disc video input terminal of the stereo receiver (or amplifier), and connect the DIGITAL/ANALOG audio output terminals of the player to the audio input terminals of the stereo receiver (or amplifier). Connect the CONTROL OUT (OUTPUT) terminal of the stereo receiver (or amplifier) to the CONTROL IN terminal of the player, using a miniature phone plug ↔ miniature phone plug connecting cord.

For details concerning method of connection and operation, please refer to the operating instructions for your stereo receiver (or amplifier).

**NOTE:**

When a connecting cord has been connected to the CONTROL IN terminal, direct control of the player with the remote control unit is not possible. Operate the player with the remote control unit by aiming it at the AV receiver or AV master amplifier.

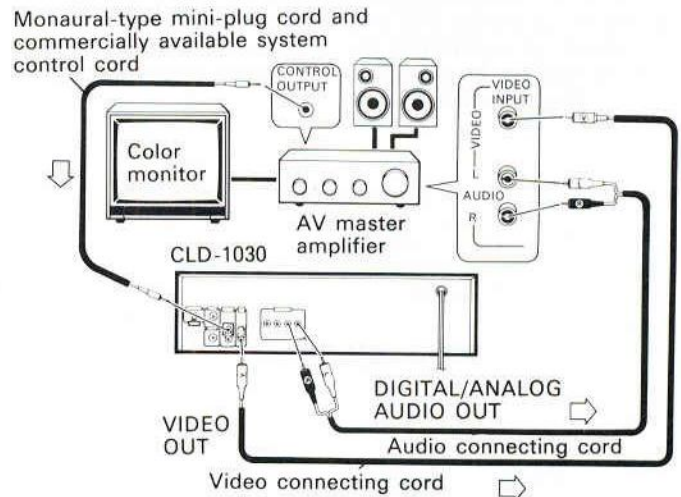

# PANEL AND REMOTE CONTROL UNIT FACILITIES

## [PLAYER FRONT PANEL]

### OPEN/CLOSE (▲) button

This button is used to open and close the disc table. Setting a disc on the disc table then pressing this button retracts the disc table in to the player and begins play of the disc. Pressing this button during play stops play and extends the table from the player.

### DOOR/INDICATORS

When power is switched on, and OPEN/CLOSE button is pressed, the door opens downward, and at the same time, the disc table is expelled outward.

### PLAY/PAUSE (▶/⏸) button

- Setting a disc on the disc table then pressing this button retracts the disc table into the player and begins play of the disc.
- Pressing this button while the disc is stopped begins play of the disc.
- Pressing this button during play pauses the play. Pressing this button again restarts the play from the point at which it was paused.
- Press this button to begin chapter programming.

### SCAN (◀◀, ▶▶) buttons

After play has begun, the disc is fast forwarded as long as the ▶▶ button is held down or fast backwarded as long as the ◀◀ button is held down. There are two speeds. The first two seconds that a button is held down the scanning is at low speed, then it changes to high speed.

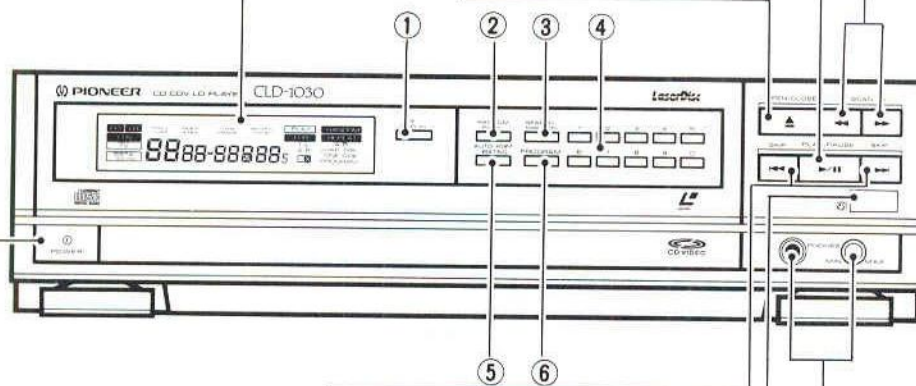

### POWER button

### SKIP (◀◀, ▶▶) buttons

- This is used to move to the head of the chapter for LaserVision Discs, or to the head of the track for Compact Discs or Compact Discs with Video.
- Pressing the ◀◀ button during entry of a program for programmed play cancels the last number input. Pressing this button again cancels the number entered before that. Each time this button is pressed, the last number still retained is cancelled (edit function). The ▶▶ button has no effect during program input.

### PHONES (headphones) jack

When you wish to use headphones, insert the plug for the headphones into the headphone jack.

### PHONES LEVEL control knob

Use to adjust the level of sound when using headphones. Turning the knob to the right increases the sound level.

### REMOTE SENSOR window

**① TIME DISPLAY button**

This is used to change the indication, the on-screen display and the indicator display.  
With disc which do not feature a table of contents (TOC), this serves as the ON/OFF button for the monitor display. (Refer to the 'INDICATORS'.)

**② RANDOM PLAY button**

This function is limited to Compact Discs and the audio portion of Compact Discs with Video. Press the button to start random playback.

**③ SEARCH/MEMORY button**

Search button function:

- Execution of search operation.
- For memory repeat operation.

Memory button function:

This button is also used to input programs for programmed play.

**④ DIGIT button (0 — 9)**

- This is used for search, track selection and program input.
- Use the DIGIT button during editing to designate the time in minutes. (This function is limited to Compact Discs and the audio portion of a Compact Disc with Video.)

**⑤ AUTO PGM EDITING (Auto Program Editing) button**

This function is limited to the Compact Discs and the audio portion of Compact Discs with Video. Press the AUTO PGM EDITING button to program selections which can be played within the designated time.

**⑥ PROGRAM button**

This button is used for programmed playback, which is playback in which the order of chapters for a LaserVision Disc, or the order of tracks for a Compact Disc or a Compact Disc with Video are changed.

**INDICATORS:**

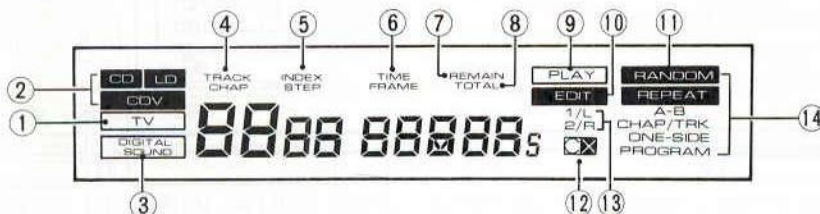

- ① TV** : Lights when the television connected to the VHF output terminal on the back of the player is receiving a TV program.  
Turned off: When a disc is being played back.  
Turned on: While TV broadcasting is being received.  
When the power is turned on initially, the indicator is not lit.
- ② CD,CDV,LD:**  
CD (Compact Disc)  
: Lights while a Compact Disc is being played back.  
CDV (Compact Disc with Video)  
: Lights while the CDV is being played back.  
LD (LaserVision Disc)  
: Lights while the LaserVision Disc is being played back.

- ③ DIGITAL SOUND** : Lights while the digital audio is output from the DIGITAL/ANALOG audio output on the back of the player.
- ④ TRACK CHAP.** : Indicates the track no. being played back for the Compact Disc or Compact Disc with Video or the chapter no. of the LaserVision Disc being played back.
- ⑤ INDEX STEP** : Indicates the index no. for the signals indexed in a music program or the program step number when a program is being played back.

- ⑥ TIME FRAME : Indicates the elapsed playing time of Compact Disc track, or the elapsed time that the audio portion of a Compact Disc with Video has played. With LaserVision Discs, it indicates the frame number for standard play LV Discs (CAV) and time number for extended play LV Discs (CLV). It indicates the time number for the video portion of a Compact Disc with Video.
- ⑦ REMAIN : Indicates the time remaining from the present playing position to the end of play for CDs or the audio portion of CDVs.
- ⑧ TOTAL : Indicates total number of selections and total playback time (TRACK/CHAP.) on the playback side of the disc. With LDs, chapter '0' is not included as one of the selections. Also, when playing a disc which does not have table of contents (TOC)<sup>1</sup>, TOTAL is not displayed.
- ⑨ PLAY : Lights during playback. Flashes when proceeding to playback and during search.
- ⑩ EDIT : Lights while editing is being performed.
- ⑪ RANDOM : Lights along with the REPEAT indicator during random play.
- ⑫ CX : Lights up when the player's CX noise reduction system is operating.  
CX is a trademark of CBS Inc. This player meets the CX EXPANDING SPECIFICATION.  
● CX can be used only when LaserVision Disc is being played back.

- ⑬ 1/L, 2/R : Indicates the audio output channel. 1/L indicates the 1st audio channel or left channel; 2/R indicates the 2nd audio channel or the right channel.  
When the power is turned on, both 1/L and 2/R light (in the STEREO mode).
- ⑭ REPEAT : Indicates the the type of repeat play during playback. REPEAT play is selected with the A or B keys of the remote control unit.  
A — B : Indicates when the repeat play of an interval between two points A and B is selected.  
CHAP./TRK. : Indicates chapter repeat with LaserVision Discs; indicates the track (selection number) which is set for repeat playback with Compact Discs and Compact Discs with Video.  
ONE-SIDE : Indicates that one side of the disc is set for repeat playback.  
PROGRAM : Indicates that program repeat play has been selected.

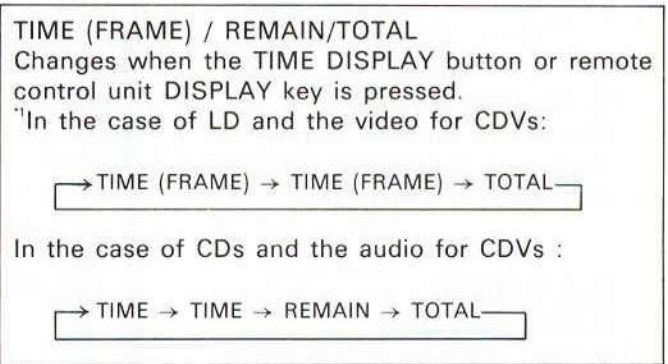

<sup>1</sup>:Applies when the disc features a table of contents (TOC) for the selection numbers and playing times recorded on the disc.  
<sup>2</sup>:The INDEX is a prerecorded signal which indicates different points within a selection or between selections. For disc which have an INDEX signal recorded on them, an INDEX indication is provided in the instructions.

**[REMOTE CONTROL UNIT]**

\* Refer to page 5 for inserting batteries in the remote control unit.

Keys for which no special instructions are given correspond to the same functions as the buttons of the player. (Refer to the section [PLAYER FRONT PANEL].)

The accessory remote control unit works commonly for LaserVision Discs, Compact Discs and Compact Discs with Video.

- The keys with white indications are for LaserVision Discs use only; Keys in other colors are for common use by all three types of discs.

**EJECT ( ■ / ▲ ) key**

This key is used to stop playback and remove the disc.

The first time this key is pressed stops the rotation of the disc. The second time this key is pressed extends the disc table from the player. If there is no disc on the disc table, the disc table is extended out from the player the first time this key is pressed.

**■, + key**

This key is used for setting the speed for multi-speed playback. (See Page 24 "Multi-speed".)

**MULTI-SPEED ( ◀ , ▶ ) key (LaserVision Disc)**

- Pressing the ▶ side of this key during playback of a standard disc plays back the disc in the forward direction at the preset speed. Pressing the ◀ side of this key during playback of a standard disc plays back the disc in the reverse direction at the preset speed (with no audio). The speed is set with the -, + key. (See Page 24 "Multi-speed".)
- This key has no effect for extended play discs and "CLV" is displayed on the screen.

**PAUSE ( || ) key**

When this is pressed, the playback is temporarily interrupted. To release the pause mode, press the PAUSE key again.

**REPEAT ( A, B ) keys**

These are used for repeat playback.

**STILL/STEP ( ◀|||, |||▶ ) key (LaserVision Disc)**

- Pressing either end of this key causes still frame playback. Then, pressing the |||▶ side of this key advances the playback one frame, while pressing the ◀||| side of this key reverse the playback one frame.
- This key has no effect for extended play discs and "CLV" is displayed on the screen.

**CHAPTER SKIP/TRACK SEARCH ( ◀◀, ▶▶ ), PROGRAM CORRECT ( ◀◀ ) key**

This key has the same functions as the SKIP button on the front of the player.

**CLEAR key**

The CLEAR key is used in the following cases:

- To stop repeat playback, to interrupt a search, or to correct input made with the DIGIT keys.
- To erase the last step of the program.
- To end program playback.
- To end random playback.

**DIGIT ( 0 - 9 ) keys**

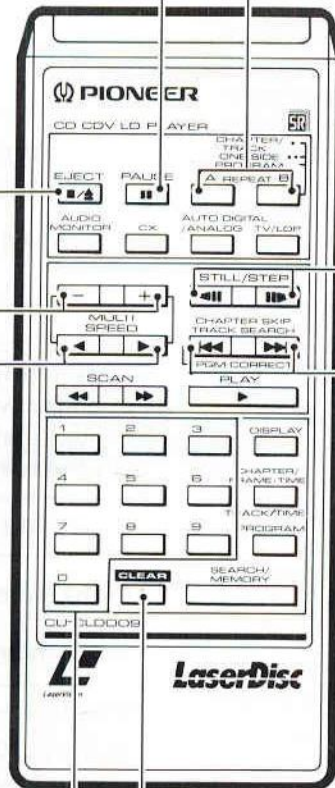



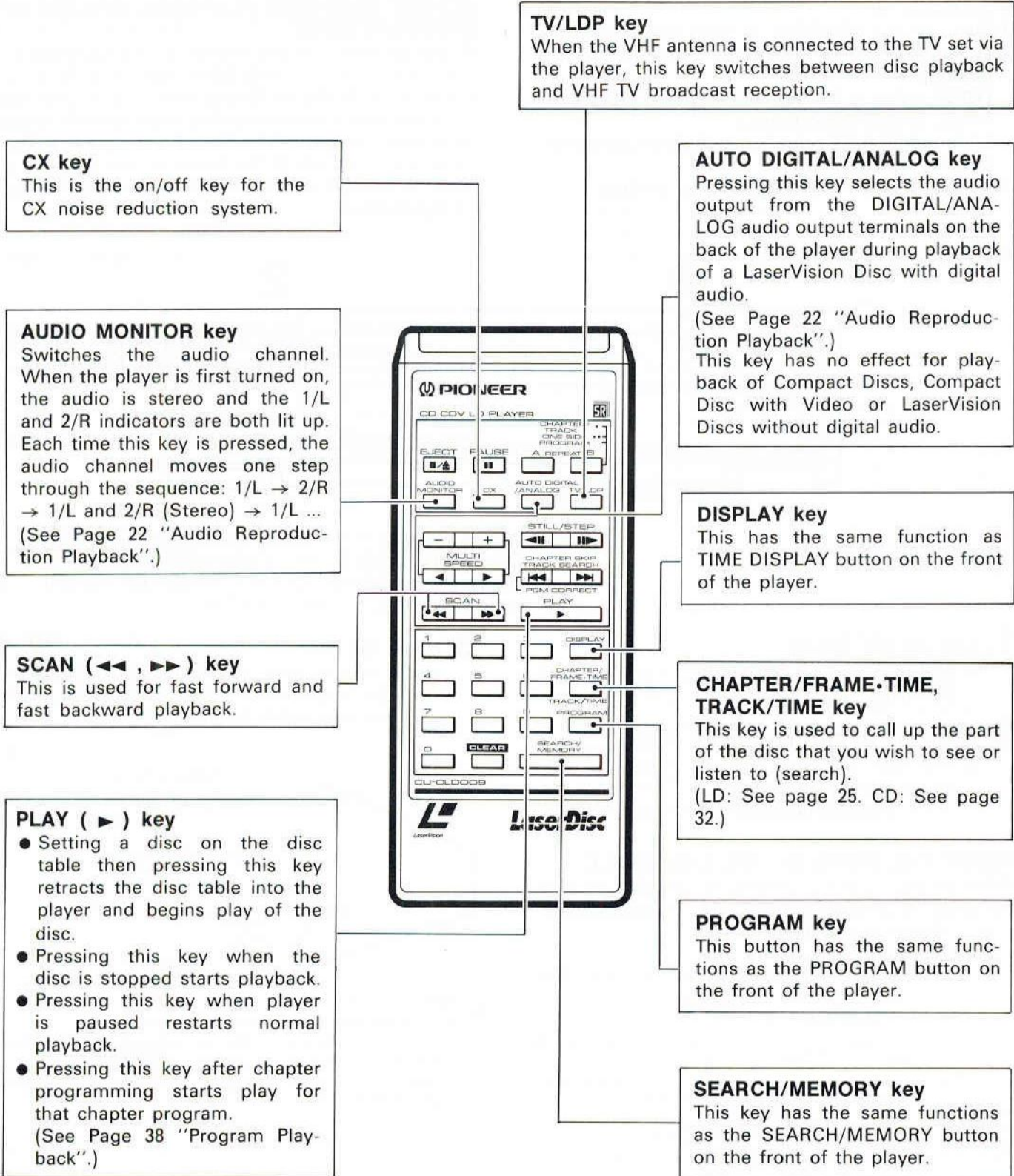

# BASIC OPERATION (FOR PLAYBACK OF LASERVISION DISCS AND COMPACT DISCS)

## [Preparations]

- Turn on your television, and set it to a channel (3 or 4) which is not being used for broadcasting.  
(When using a TV set with a video input terminal, select video input.)  
When using a TV monitor, switch on power to the TV monitor.
- Switch on power to your stereo system.

## BEFORE BEGINNING PLAYBACK, BEWARE OF EXCESSIVE INPUT.

A characteristic of the digital sound recorded on Compact Discs, Compact Discs with Video and LaserVision with Digital Sound Discs, is a very low noise level combined with a very large dynamic range. As a result, be extremely careful when playing back these discs and adjust the sound volume properly in order to prevent damage to your speakers from an excessive input.

## TO BEGIN PLAYBACK

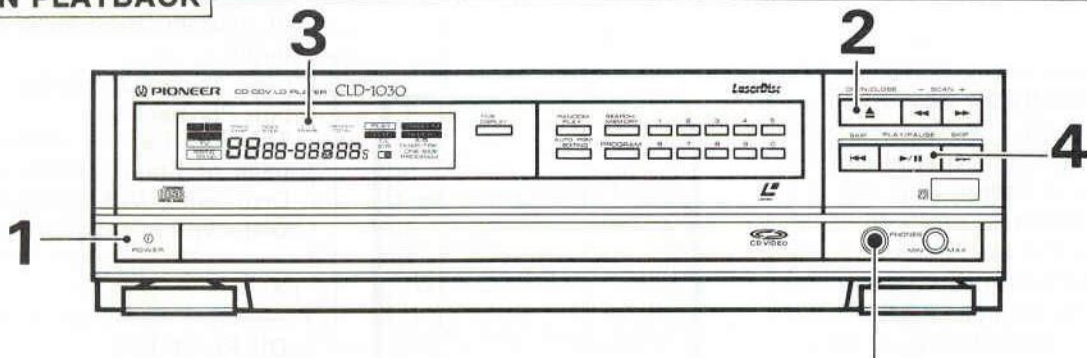

[When listening to the player through headphones:]  
Connect headphones with a standard stereo jack to the player headphone input. Volume can be adjusted with the PHONES LEVEL control knob.

### 1. Turn on the player.

- The screen of the TV set or TV monitor will turn blue.

### 2. Press the OPEN/CLOSE (▲) button.

- The door will open, and the disc table will emerge a specified distance. The disc table will not open or close if power is not turned on.

## ABOUT THE SHAPE OF THE DISC TABLE

When setting each size of disc, set the disc so that the edge is properly aligned with the appropriate guides shown in the figure.

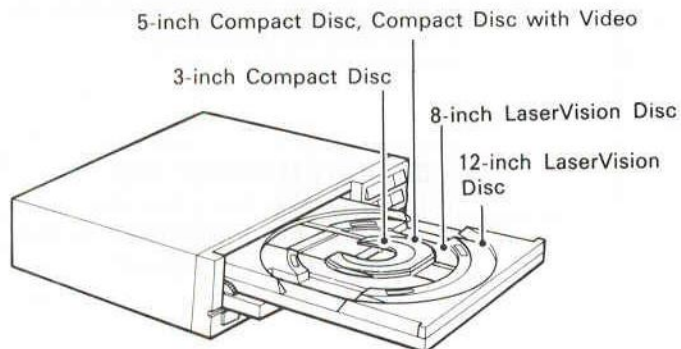

### 3. Load the disc

- Be sure to load the disc so that the label of the side you wish to play is facing up, in the same way as for audio record.

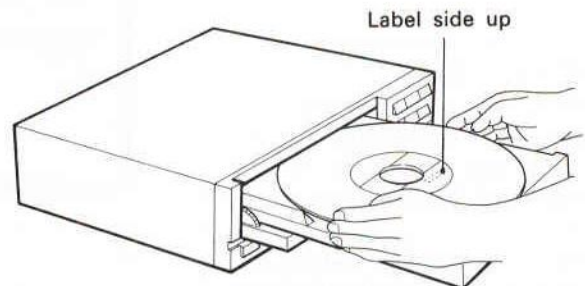

#### NOTE:

- Only one disc can be loaded at any one time. Loading a LaserVision Disc, a Compact Disc or a Compact Disc with Video on top of one another may result in breakdown, or in scratching of the discs. Please only load one disc at a time.

#### 4. Press the PLAY/PAUSE (▶/⏸) button.

- The disc table is retracted into the player and the playback begins.
- The OPEN/CLOSE button can be pressed instead of the PLAY/PAUSE button to retract the disc table and begin playback (autostart)

For a LaserVision disc, the side of the disc is displayed on the screen (although there are some discs without the side display).

#### [Screen display]

(LaserVision Disc)



(Compact Disc)

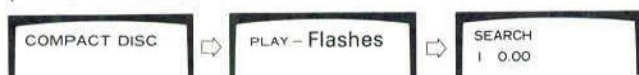

(Compact Disc with Video)

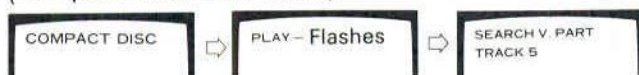

#### [Player display]

(LaserVision Disc)



(Compact Disc)



(Compact Disc with Video) — Video portion —  
When the video portion begins from the 5th track.



### TO STOP PLAYBACK

When one side of a disc is played to the end, playback automatically stops and the disc stops rotating. To stop playback part way through a disc, proceed as follows.

1. Press the OPEN/CLOSE button on the player, or the EJECT key (■/▲) on the remote control unit.
  - When the OPEN/CLOSE button on the player is pressed, the disc stops rotating, and the disc table emerges.
  - When the EJECT key on the remote control unit is:
    - Pressed once : The disc stops rotating.
    - Pressed twice : The disc stops rotating and the disc table emerges.

(LaserVision Disc)



2. Remove the disc
  - Return the disc to its jacket or case, and store it vertically.
3. Press the OPEN/CLOSE (▲) button.
  - The disc table is retracted into the player.
4. Press the power switch again to switch off the power.

#### NOTE:

Do not switch off the power with the disc table out of the player.

A strong force applied to the disc table while it is out of the player can damage it. Depending on where the player is, there may also be a danger of the player falling. Always retract the disc table back into the player except when taking out or mounting a disc.

#### CAUTION

- Do not place anything on the disc table other than a disc.
- Do not open the door with your hands during playback.
- Do not tilt or lift up the player during playback, as this could result in damage to the disc. If you need to move the player, first take out the disc, switch off the power, and remove the plug from the power outlet.
- If the picture is not clear, adjust the fine tuning of your TV set.
- If fingerprints or dirt adheres to the playback surface of the disc, the video and audio quality will be impaired. Before loading a disc, clean the disc's bottom surface if it is dirty (this is the opposite side to the label side, but it is the side with the signal which will be played back).

**TV CHANNEL ADJUSTMENT  
(WHEN THE PICTURE IS NOT CLEAR)**

Confirm that the CHANNEL SELECTOR switch on the rear panel of the player, is set to the same channel as the channel used for disc playback.

1. Set your TV set to the channel (3 or 4) used for disc playback.
2. Start disc playback.
3. Adjust the fine tuning of your TV set so that a clear picture is obtained.

(The method of fine tuning differs from one TV set to another. Please refer to the operating instructions for your TV set.)

WHEN STRIPES OR NOISES APPEAR ON THE SCREEN, PLEASE KEEP VHF ANTENNA CABLE AWAY FROM POWER CORD.

**NOTE:**

*In an area where the TV broadcast signal is weak, slanting stripes may appear on the TV screen when the TV/LDP key is pressed to receive a TV broadcast. This does not always indicate a problem. The stripes should be eliminated by turning off power to the player.*

*In such cases, or when you wish to watch TV for long periods of time, we recommend that you turn off the power switch of the player.*

**WHEN USING A TV SET WITH VIDEO AND AUDIO INPUT TERMINALS**

When using the video input terminal of your TV, switch to the broadcast using the controls of your TV.

**TO WATCH A TV BROADCAST**

When a VHF TV antenna has been connected to your TV via the player's ANTENNA terminal, in accordance with the connection example given in these instructions (page 10), TV broadcasts can be received normally by proceeding in one of the following two ways:

- **By switching off power to the player**  
Before switching off power, first perform the steps in "TO STOP PLAYBACK", and stop disc playback.
- **By making the TV indicator on the front panel turn on. (Use the TV/LDP key on the remote control unit.)**

In either case, the signals from the VHF antenna are fed to the TV set via the player.

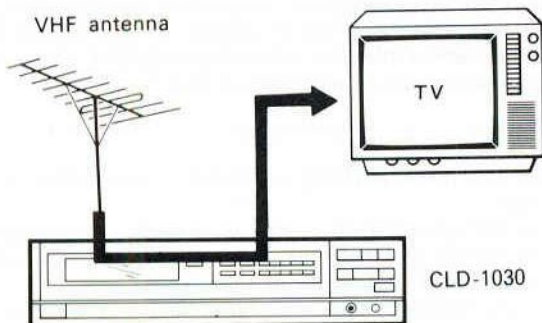

Press the TV/LDP key on the remote control unit so as to make the indicator turn on, or turn off power.

# REMOTE CONTROL OPERATIONS

When operating the remote control unit, point the infrared signal transmitter part of the unit at the remote control receiver (REMOTE SENSOR) on the front panel of the player. The remote control unit may be used within a range of about 7 meters (23 feet) from the remote sensor, and within angles of up to about 30 degrees.

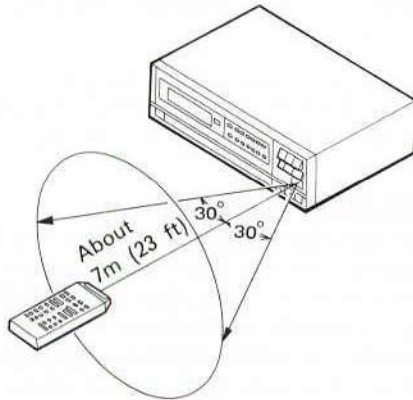

## NOTE FOR USING THE REMOTE CONTROL UNIT

- If there is any obstacle between the remote control unit and the player, or if the unit is held at too large an angle relative to the front panel of the player, the signal from the remote control unit may fail to reach the remote sensor.

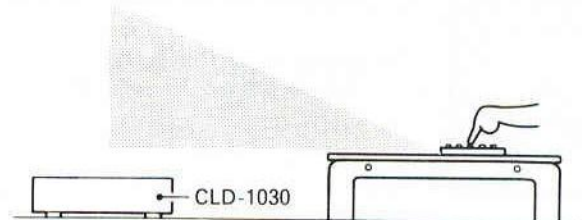

- If the player is operating in the vicinity of other appliances generating infrared rays, or if other remote control devices using infrared rays are used near the player, the player may operate improperly. Conversely, if the player's remote control unit is operated in the vicinity of other appliances which use an infrared remote control device, the other appliance may operate improperly. If this should happen, change the place of installation so that improper operation does not occur.
- If the range of operation of the remote control unit becomes too short, replace the batteries.
- When the unit is not to be used for a long period of time (more than one month), remove the batteries to prevent them from leaking inside the compartment. If leakage occurs, wipe up the liquid inside the compartment and replace the batteries with new ones.
- Do not place books or other objects on the remote control unit, since they might depress the buttons and run down the batteries.

# LASERVISION DISC PLAYBACK FUNCTIONS

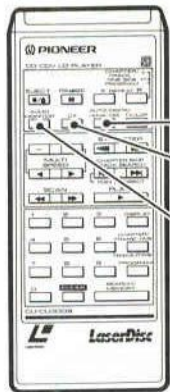

- AUTO DIGITAL/ANALOG key  
(Switches between digital audio and analog audio)
- CX key  
(Switches the CX system on and off)
- AUDIO MONITOR key  
(Selects stereo, 1/L, or 2/R)

## AUDIO REPRODUCTION PLAYBACK OF STEREO DISCS

When power is turned on, the player goes into stereo playback mode (audio 1/L and 2/R indicators both light), and disc playback is performed in this mode. If either of the 1/L or 2/R indicators is off, press the AUDIO MONITOR key on the remote control unit to make both indicators light.

The sound played back via TV set connected to the VHF output terminal, will not be in stereo.

## BILINGUAL discs, MULTI AUDIO discs

Press the AUDIO MONITOR key until the audio indicator for the channel you want to listen to lights up and the audio indicator for the other channel goes out. The audio selection moves through the sequence: 1/L → 2/R → stereo

## SOUND SELECTION WITH THE AUDIO MONITOR KEY

AUDIO MONI-TOR key	VHF Output Signal	Audio Output Terminal		Indicators on display	Screen display
		1/L	2/R		
	Mixture of 1/L and 2/R	1/L	2/R	1/L 2/R	
	1/L	1/L	1/L	1/L	
	2/R	2/R	2/R	2/R	

## CX SYSTEM

(The CX system key is effective only for analog sound)

When the CX system indicator does not light when playback of a disc with the mark begins, this indicates that the disc does not perform CX switching automatically. Please press the CX key on the remote control unit, so as to make the CX system indicator light.

Some discs have codes recorded on them which switch the CX system on and off automatically. When these discs are played back, switching of the CX system is carried out automatically. Also, once automatic switching has been carried out, switching with the CX key cannot be performed.

*CX is a trademark of CBS Inc.*

*This player meets the CX EXPANDING SPECIFICATION.*

### NOTE:

*When playing back a disc without the mark, always switch the CX system off. If a disc without the mark is played back with the CX system on, the sound will not play back naturally.*

## DISCS WITH DIGITAL AUDIO

When a disc with digital audio is played, the DIGITAL SOUND indicator on the front panel lights up. The audio signals output from the DIGITAL/ANALOG audio output terminals on the back of the player can be selected with the AUTO DIGITAL/ANALOG key on the remote control unit. (When the power is first switched on, the player is in auto digital mode.)

The ANALOG terminal audio output terminals only output analog audio signals. Analog audio is not output with Compact Discs or Compact Discs with Video.

## [Switching the audio signals with the AUTO DIGITAL/ANALOG key]

Mode	Screen display	Audio output		
		DIGITAL /ANALOG	ANALOG	VHF
AUTO DIGITAL		Digital	Analog	Digital
ANALOG		Analog	Analog	Analog

- Digital audio output can be switched between 1/L, 2/R, and stereo with the AUDIO MONITOR key in the same manner as analog audio output. Switching the channel for analog audio output also switches the channel for digital audio output.
- Audio can be switched over between stereo, 1/L, 2/R for Compact Discs and Compact Discs with Video.

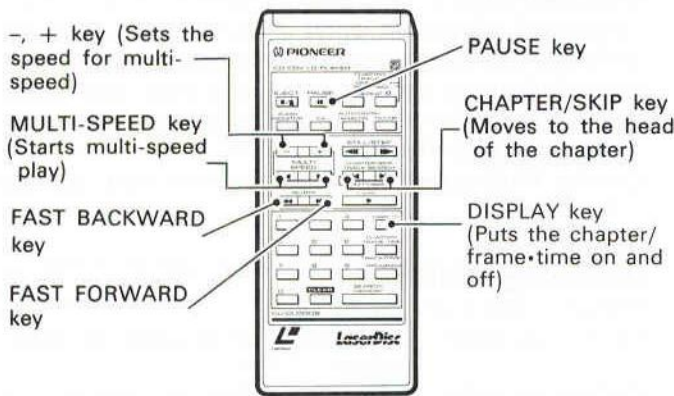

**PAUSE**

Pressing this key causes the video and sound to disappear, and temporary interruption of playback. The screen becomes blue, and an indication appears of the side being played back ("SIDE A" or "SIDE B") and the word "PAUSE" appears. Pressing the key again causes playback to resume from the point of interruption. (In the case of some discs the "SIDE" indication does not appear.)

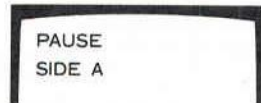

**NOTE:**

- If the screen is displaying the chapter and frame or time, that display takes priority and "PAUSE" is not displayed.
- When the PAUSE key is pressed during search operation, the player pauses when the search ends.
- When the pause mode is cancelled while playing an extended play disc, the point from which playback resumes may differ slightly from the point where playback was interrupted.

**DISPLAY**

Displays the elapsed playing time from start of the discs to the selection that is being played (or the elapsed playing time from the beginning of the video portion with CDVs) on the indicators on the front of the player or on the TV screen. With discs featuring a table of contents, when you press the TIME DISPLAY button or the remote control unit DISPLAY key, TOTAL (the total number of selections on the disc and the total playing time) and TIME (the number of the selection being played and the time that it has been playing) are displayed alternately.

- Press the DISPLAY key once to display the TOTAL information on the monitor screen; press it again to display the TIME information.

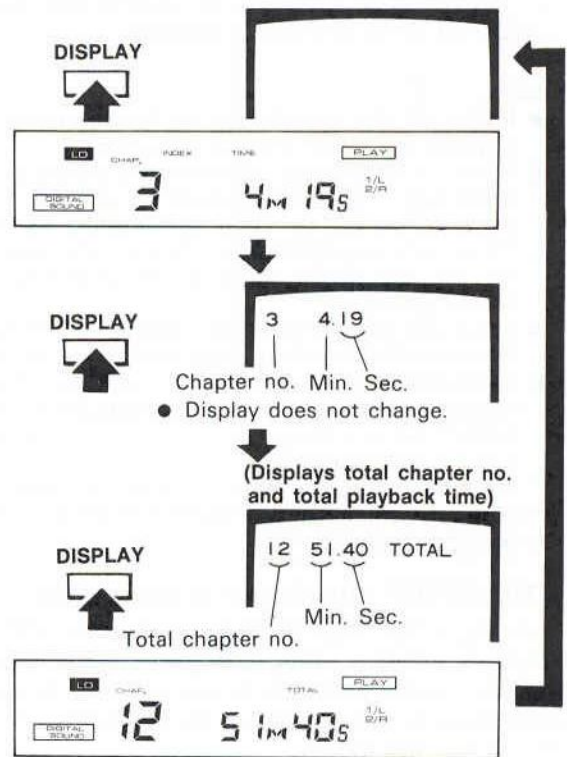

**SCAN**

After playback has begun, pressing either end of this key causes fast forward or fast backward playback.

- ▶▶ : Fast forward
- ◀◀ : Fast backward

The scan speed may be one of two speeds. For about two seconds after the key is pressed, the scan speed is fairly slow, after that, it changes to high speed.

- The SCAN speed does not change to high speed in the video portion of CDVs.

**CHAPTER SKIP**

(Discs on which chapter numbers have been recorded)

This function causes the player to jump to the beginning of the next chapter, or to jump to the beginning of the chapter currently being played.

This operation can be carried out with either the CHAPTER SKIP key on the remote control unit or with the SKIP buttons on the player.

Pressing the ► side: Player jumps to the beginning of the next chapter.

Pressing the ◀ side: Player jumps to the beginning of the chapter currently being played.

(Skipping to Chapter 3)

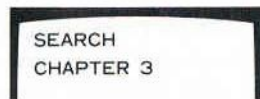

If the key is repeatedly pressed, the player jumps to the beginning of chapters in accordance with the number of times the key is pressed.

**NOTE:**

- If chapter skip operation is performed during repeat playback, the repeat mode is cancelled.
- When chapter skipping in the reverse direction, be careful of the number of times you press the key. The first time you press the key, the player jumps to the beginning of the currently playing chapter. The second time you press the key, the player jumps to the beginning of the preceding chapter.
- In the case of discs on which chapter numbers have not been recorded, the chapter skip function cannot be used.
- If skipping is performed beyond the range of the recorded chapter numbers for LaserVision Discs without a table of contents, the player enters the play mode at the end of the discs, then stops playing back approx. 10 secs. later. If you skip to a number which is greater than the recorded number, please reverse direction within 10 seconds.

**STILL/STEP (Standard play discs only)**

Pressing either end of this key causes still frame playback. Following this, each press of the ► end of the key causes playback to advance one frame, and each press of the ◀ end of the key causes playback to reverse one frame.

To cancel still frame playback, press the PLAY/PAUSE (▶/◻) button on the player or PLAY (▶) key on the remote control unit.

\* In the case of rapidly changing scenes, it may not be possible to obtain completely still frames. This is not a fault of the player or disc.

**AUTOMATIC PICTURE STOP**

Some discs have special signals recorded on them called picture stop codes. When such discs are played at either normal speed or in multi-speed (with the exception of double and triple speed) mode, the player automatically stops at the frames specified by the picture stop codes, and plays back a still frame.

**MULTI-SPEED (Standard play disc only)**

With this function you can choose from a fast 3-times normal playback speed to an ultra-slow, one frame every 3 seconds, allowing you to enjoy playback at whatever speed you desire.

During multi-speed playback, sound can not be output.

**[Executing multi-speed]**

Pressing the multi-speed key:

On the ► side: Plays the disc forward at multi-speed.

On the ◀ side: Plays the disc backwards at multi-speed.

**[Speed Selection]**

When power is turned on "1/4" is selected.

Using the "+" and "-" keys, selection of 9 speeds is possible.

During the time the "+" and "-" keys are being pressed, the speed is displayed on the screen.

"-" Key	Screen Display	Speed	"+" Key
↓	× 3	3-times play mode speed	↑
	× 2	2-times play mode speed	
	× 1	Same as play mode speed	
	1 / 2	1/2 play mode speed	
	1 / 4	1/4 play mode speed	
	1 / 8	1/8 play mode speed	
	1 / 16	1/16 play mode speed	
	STEP 1	Plays one frame every second	
	STEP 3	Plays one frame every 3 seconds	

The selected speed is remembered even when another playback mode is selected. When playback is stopped, the speed is restored to 1/4 of play mode speed.

During playback modes other than multi-speed mode, the player can also accept "+" and "-" key operations, so the speed of multi-speed playback can be set in advance.

When the multi-speed operation keys (◀, ▶) are pressed during chapter number and frame/time number display, the speed is displayed.

**[Ending multi-speed play]**

To end the multi-speed play, press the PLAY (▶) key.



## CHAPTER NUMBER AND FRAME/TIME NUMBER DISPLAY

LaserVision Discs have chapter numbers, frame numbers and/or time numbers recorded on them, at the time when the video and sound are recorded. Each time the DISPLAY key is pressed, this information is alternately displayed and erased on the screen.

### Chapter numbers (Standard play and Extended play discs)

These indicate divisions within a disc program, and correspond to the chapter numbers in a book. Some discs do not have chapter numbers recorded on them. In the case of such discs, chapter numbers are not displayed.

### Frame numbers (Standard play discs)

Frame numbers are allocated one by one to each frame from the start of the disc program. These correspond to the page numbers in a book.

### Time numbers (Extended play discs)

These represent the elapsed time from the start of the disc for normal playback mode. In the case of some discs time numbers are recorded with minutes as the smallest units, while with other discs, the time numbers are recorded with seconds as the smallest units.

Standard play disc

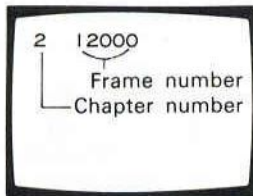

Disc with second unit time numbers

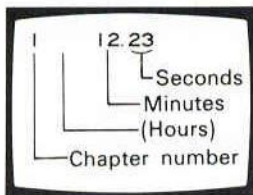

Extended play disc

Disc with minute unit time numbers

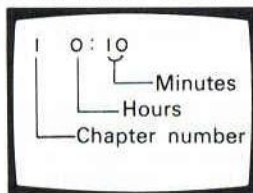

[Player display]  
Example: standard play disc



Shows the chapter number Shows the frame number

## SEARCH (RANDOM ACCESS)

This function searches for the required scene using either frame numbers, chapter numbers, or time numbers. To search for a scene, use the remote control unit after a picture appears on the screen. The same operation can be performed for the video portion of Compact Discs with Video. In addition, both forward and reverse search is possible for both the video and audio portions.

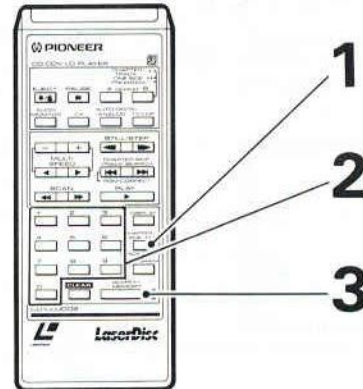

### NOTE:

- If you specify a chapter number, frame number or a time number which is larger than maximum recorded number, the player will search near the end of the side being played. When playing a disc with TOC, search for a chapter number greater than the one recorded on the disc cannot be done.
- If the PLAY key or multi-speed key is pressed during search operation (when the PLAY indicator is flashing during the time the player is searching for the specified scene), in the case of a standard play disc, the player will play back in that mode (play or multi-speed) after the search operation has been completed.
- Pressing the PAUSE key during a search pauses the disc at the point searched for.

**FRAME NUMBER SEARCH  
(Standard play discs only)**

This function allows you to search for the specified frame number, and plays it back as a still picture.

**[Example]**

To search for frame number 12340

**1. Press the CHAPTER/FRAME-TIME key**

If the chapter is displayed, press the CHAPTER/FRAME-TIME key again.

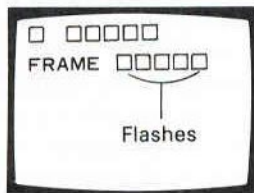

FRAME □□□□□ appears on the screen. The number which appears is the frame number which was previously searched for.

**2. Press 1, 2, 3, 4, 0**

The indication FRAME 12340 appears on the screen.

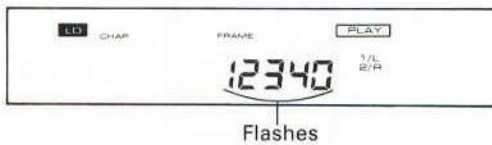
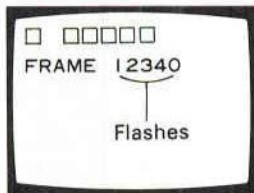

**3. Press the SEARCH/MEMORY key**

The screen turns blue and the PLAY indicator flashes.



The image of frame 12340 appears as a still picture.



Chapter to be searched for (Example: 3)



**CHAPTER NUMBER SEARCH**

(For standard play and extended play discs on which chapter numbers have been recorded.)

The player locates the head of the specified chapter and shows a still picture if the disc is a standard disc or begins to play if the disc is an extended play disc.

**[Example]**

To search for the beginning of Chapter 3

**1. Press the CHAPTER/FRAME-TIME key**

If the frame or time is displayed, press the CHAPTER/FRAME-TIME key again.

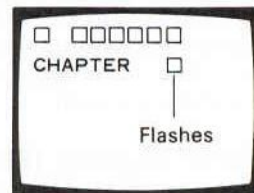

CHAPTER □ appears on the screen. The number which appears is the number of the chapter which was previously searched for.

**2. Press 3**

The indication CHAPTER 3 appears on the screen.

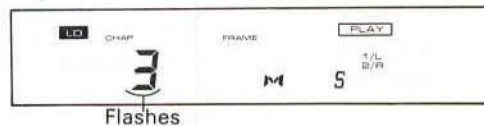
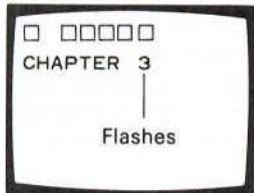

**3. Press the SEARCH/MEMORY key**

The screen turns blue and the PLAY indicator flashes.

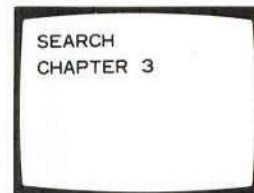

The start of Chapter 3 appears as a still picture in the case of a standard play disc, or is reproduced in play mode in the case of an extended play disc.



Frame number or time numbers to be searched for



**TIME NUMBER SEARCH  
(Extended play discs only)**

This function allows you to search for the scene corresponding to the elapsed playing time from the beginning of a program.

**[Example]**

To search for the picture 12 minutes from the beginning of a program.

**For discs with "second" time numbers**

1. Press the **CHAPTER/FRAME-TIME** key

(TIME □□.□□ will be displayed)

If the chapter is displayed, press the CHAPTER/FRAME-TIME key again.

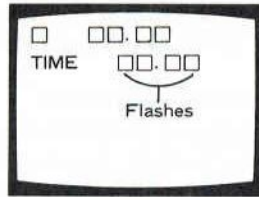

2. Press **1, 2, 0, 0**  
(TIME 12.00 will be displayed)

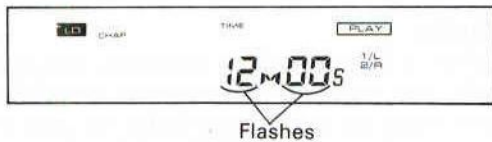
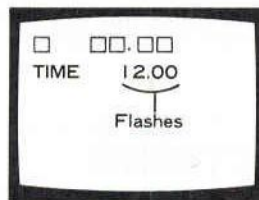

3. Press the **SEARCH/MEMORY** key

The screen turns blue and the PLAY indicator flashes.

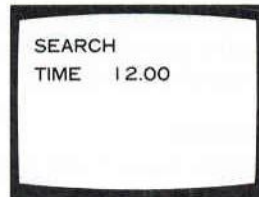

(Playback will start from the picture that is 12 minutes from the beginning of the program.)

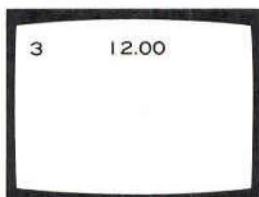

Chapter to be searched for (Example: 3)



**NOTE:**

Depending on the disc, time numbers may be recorded with either seconds as the minimum unit, or with minutes as the minimum unit.

With these different types of discs, searching may be performed to either second accuracy or minute accuracy respectively. As the two types of discs require slightly different methods of numeric entry, please be careful when entering numerals.

**For discs with "minute" time numbers**

1. Press the **CHAPTER/FRAME-TIME** key

(TIME □:□□ will be displayed)

If the chapter is displayed, press the CHAPTER/FRAME-TIME key again.

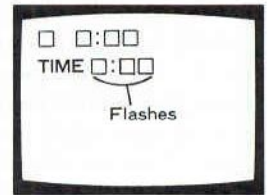

2. Press **1, 2**  
(TIME 0:12 will be displayed)

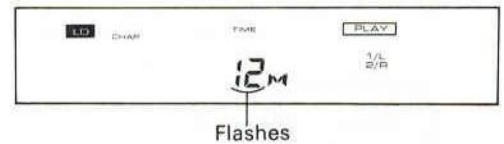
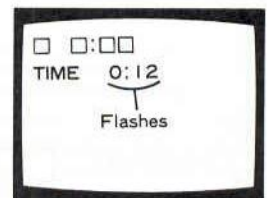

3. Press the **SEARCH/MEMORY** key

The screen turns blue and the PLAY indicator flashes.



(Playback will start from the picture that is 12 minutes from the beginning of the program.)



Chapter to be searched for (Example: 3)



For the video portions of Compact Discs with Video, a function corresponding to a time number search (for discs which are recorded in seconds) and a track number search (which corresponds to a chapter number search) is possible. With a track number search, TRACK is displayed instead of CHAPTER.

**ABBREVIATION OF SEARCH PROCEDURE**

The numerals entered during the search operation are not modified until either disc playback stops, or until a new numeric entry is made.

If you want to search for the same picture indicated by the numeric display which appears when the CHAPTER/FRAME-TIME key is pressed, you can search for the picture by simply pressing the SEARCH/MEMORY key.

Also, if you want to change the search numbers (frame/time or chapter number search) which you just entered (while playing the same disc), you can simply begin with the digit key entry operation. You should not begin by pressing the CHAPTER/FRAME-TIME key.

**Beginning play with a chapter search (direct chapter start)**

Setting a disc on the disc table, then starting a chapter search, begins play from the specified chapter. It is also possible to resume play with a chapter search after play has been stopped.

In this case, even if the disc is a standard play disc, the player begins to play once it finds the specified chapter. (Normally, after a chapter or time is found on a standard play disc, that spot is shown as a still frame.)

**Correcting the input number**

If the wrong number key was pressed, press the CLEAR key then enter the correct number.

**Ending a search**

Pressing the CLEAR key during search key input, sets the search number to 0. Pressing the CLEAR key again at this point cancels the search number entry. Also, pressing the CLEAR key during search mode will cancel the search and start video playback from the point the CLEAR key was pressed.

**COMPACT DISC PLAYBACK FUNCTIONS**

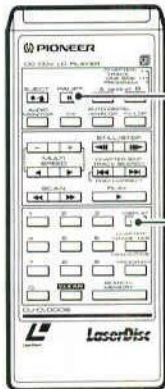

PAUSE key

DISPLAY key  
(Switches between display of the current track and time, the remaining time, and the total number of tracks and total playing time)

**Audio**

When a Compact Disc is played, the AUDIO 1/L and 2/R indicators and the DIGITAL SOUND indicator on the front of the player light up and the audio is output from the DIGITAL/ANALOG audio output terminals on the rear of the player. Compact Disc audio signals are not output from the ANALOG audio output terminals.

**PAUSE**

Press the PAUSE key on the remote control unit or the PLAY/PAUSE (▶ / ⏸) button on the player. The word "PAUSE" is displayed, and the current track number, minute and second flash on the screen.

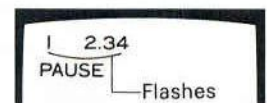

Pressing the key again causes playback to resume from the point of interruption.

**NOTE:**

- During track program play, "PAUSE" is not displayed. PAUSE mode is indicated by the flashing of the current track number, minute and second.

**RANDOM PLAYBACK**

- This is for playback of Compact Discs and the audio portion of Compact Discs with Video.
- The tracks of the inserted disc will be played at random. After all the tracks are played, random playback will be repeated.

**1. During playback mode, press the RANDOM PLAY button.**

The "RANDOM" and "REPEAT" indicators will light, and random playback will start.

**2. During random playback, press the RANDOM PLAY button again. Another track selected at random will be played.**

**■ Cancelling random playback**

- The random play mode can be cancelled by pressing the CLEAR key or by selecting a specific track.

**TRACK NUMBER AND TIME DISPLAY**

The number of the track being played and the time elapsed from the start of that track are displayed on the indicator display on the front of the player and the TV screen.

Each time the TIME DISPLAY button on the player or DISPLAY key on the remote control unit is pressed, the display changes. 'REMAIN' indicates the time remaining until the end of the disc; 'TOTAL' indicates the total number of tracks recorded on the disc and the total playing time of the disc; 'TIME' indicates the track no. being played and playback time. These indications are given alternately.

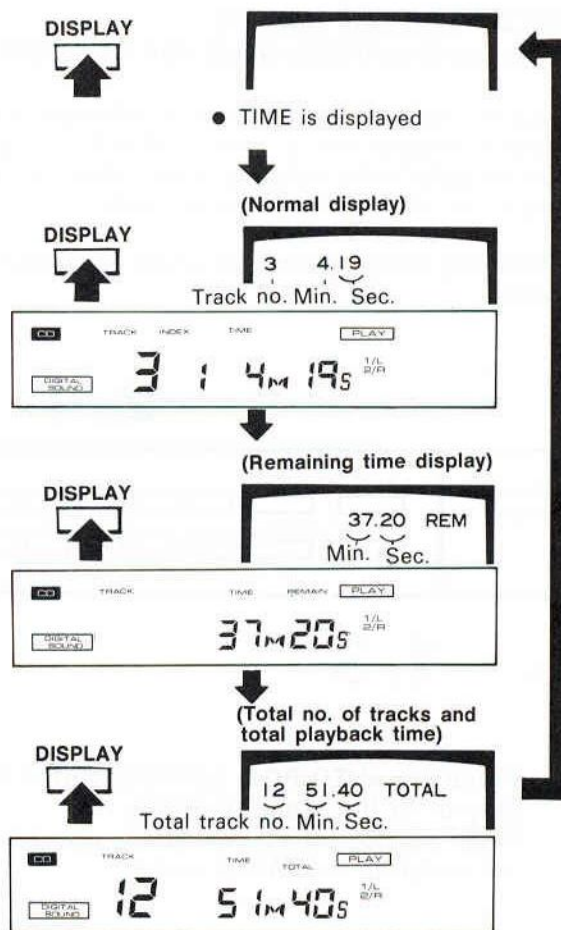

REMAIN is not displayed when the video portion of the Compact Disc with Video is being played back.

**AUTO PROGRAM EDITING**

(Programming tracks which can be played back within a desired time)

Once the desired playing time is selected, the selections desired are programmed into the player automatically in the selected order within the designated time, starting from the 1st track.

[Example] Programming in order from the 1st track

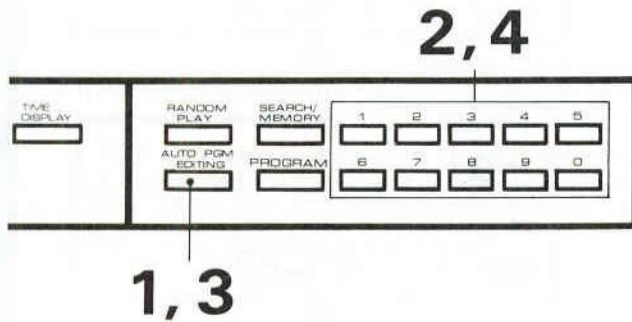

**1. Press the AUTO PGM EDITING button during play or in the standby mode.**

When you press the button during play, operation will switch to the PAUSE mode.

**2. Set the playing time in minutes with the DIGIT buttons.**

The selections which can be played within the preset time will begin playing automatically in order from track 1.

[For subsequent program]

**3. Press the AUTO PGM EDITING button. PAUSE is programmed automatically.**

**4. Set the playing time in minutes with the DIGIT buttons.**

Program the selections to playback during the desired time, starting with the selection which follows the last selection programmed in steps 1 and 2 above.

The last selection no. programmed and the playing time will be displayed.

When programming from the desired selection, perform steps 1 — 4 above after designating the selection number with the DIGIT buttons beforehand.

**NOTE:**

- When programming for more than 9 minutes, press the DIGIT buttons within two seconds of each other. If more than two seconds elapses between pressing the buttons, the designated time will be interpreted as less than 10 minutes.
- When programming with discs which have more than 20 selections on them, there will be occasions when the desired programming cannot be set.
- Programming cannot be performed when at least 1 selection cannot be programmed within the designated playing time.

**Operation example**

When recording from a Compact Disc which contains ten selections for 43 min. 27 sec. on a 46-min. cassette tape (23 min. recording possible on one side), program selections for 23 min. on one side and selections for the remaining 23 min. on the other side.

Key operation	Indicator display	On-screen display	Key operation	Indicator display	On-screen display
[AUTO PGM EDITING]	1 0 M S Flashes	EDIT 1 0 MIN Flashes	[AUTO PGM EDITING]	6 0 M S Flashes	EDIT 6 0 MIN Flashes
[2] [3]	23M00S	EDIT 23MIN	[2] [3]	23M00S	EDIT 23MIN
	5 5 22M20S	EPGM 5 22:20		10 11 21M07S	EPGM 10 21:07

Program from the 1st to the 5th tracks; playing time of 22 min. and 20 sec.

After programming a pause, program from the 6th to the 10th tracks; playing time of 21 minutes and 07 seconds.

[Canceling the auto program editing mode]

Press the AUTO PGM EDITING button before specifying the time.

**[Procedure]**

When auto program editing has been selected for the first playing session

**1. Press the PLAY/PAUSE button**

Operation can be performed in this instance. It can also be performed by pressing the PLAY key of the remote control unit. The player will stop after the programmed selections are played.

When auto program editing has been selected for the first two playing sessions

**1. Press the PLAY/PAUSE button**

Operation can be performed in this instance. It can also be performed by pressing the PLAY key of the remote control unit. The player will pause after the first programmed session is played.

**2. Press the PLAY/PAUSE button again**

Operation can be performed in this instance. It can also be performed by pressing the PLAY or PAUSE key of the remote control unit. Playing will start with the selections programmed in the second programming session.

**Stopping Play and Clearing Programs**

Follow the same procedure as for normal programming. (See page 40 "CANCELLATION OF PROGRAM PLAYBACK")

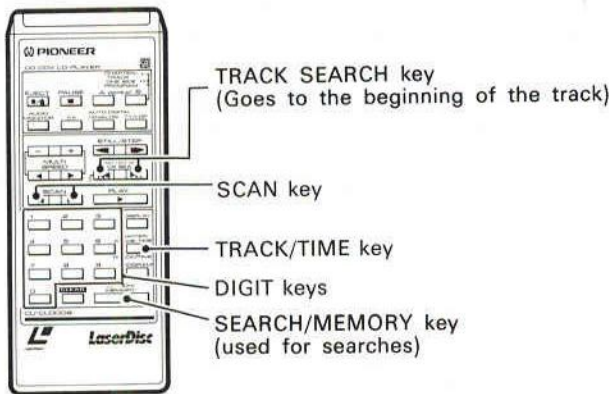

**TRACK SEARCH (Skip selection)**

This operation can be carried out with either the TRACK SEARCH key on the remote control unit or with the SKIP buttons on the player.

- ▶▶ side: Search for the start of the next track
- ◀◀ side: Search for the start of the track currently being played

This operation can be carried out with either the TRACK SEARCH key on the remote control unit or with the SKIP buttons on the player.

(The beginning of the third track)

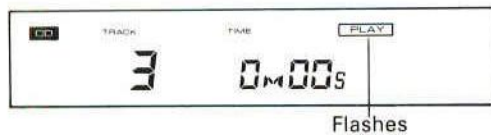
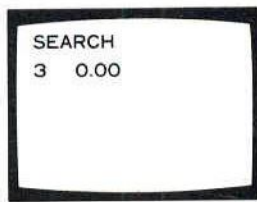

**NOTE:**

- If the TRACK SEARCH key is pressed during the pause mode, the player returns to pause mode after the jump.
- Be careful when you press the key to jump in the reverse direction. The first time you press the key, the player jumps to the beginning of the track currently playing. The second time you press the key, the player jumps to the beginning of the previous track.
- If the forward track search key is pressed during playback of the last track on the disc, or if the player is in pause mode over the last track on the disc, the player does not accept the command from the key. The player also does not accept commands for track searches beyond the last track.
- The track number can also be specified with the DIGIT keys. See the section on "TRACK NUMBER SEARCH (direct selection)".

**SCAN (FAST FORWARD, FAST BACKWARD)**

These operations are used after the playback has begun.

They can be carried out with the SCAN key on the remote control unit or with the SCAN buttons on the player.

▶▶ : Fast forward ◀◀ : Fast backward  
When scan operation is performed in the play mode, the playback sound can be heard faintly. When the scan operation is performed in the pause mode, the scan operation is performed without sound, and when the key is released, the player returns to the pause mode. The speed at which the scan operation is performed, is increased in two stages. During the first two seconds following the pressing of the key, low speed scan operation is carried out. Following this, high speed scan operation is carried out.

If forward scan operation is performed to the end of the disc, the player enters the pause mode. The player also enters the pause mode, if backward scan operation is performed to the beginning the disc.

**SEARCH (RANDOM ACCESS)**

This function enables you to specify the track number or the point in time on the disc of the spot you wish to hear. Use the remote control unit for searches once the playback has begun.

**TRACK NUMBER SEARCH (Direct selection)**

This function allows you to search for the start of the specified track number, and plays it back.

**[Example] To search for Track 3**

**1. Press 3**

TRACK 3 appears on the screen.

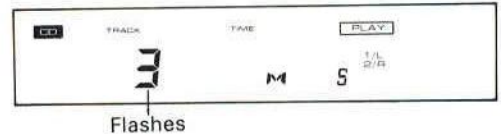
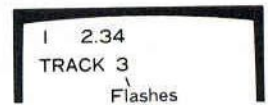

**2. Press the SEARCH/MEMORY key**

The player searches for the 0 minute 00 second point on Track 3, and then begins playback.

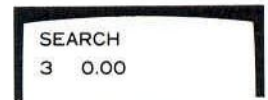



**TIME NUMBER SEARCH**

This function allows you to search for the point corresponding to a specified time in minutes and seconds, from the start of a specified track.

**[Example] To search for the point 1 minute and 23 seconds from the beginning of Track 3**

**1. Press 3**

TRACK 3 appears on the screen.

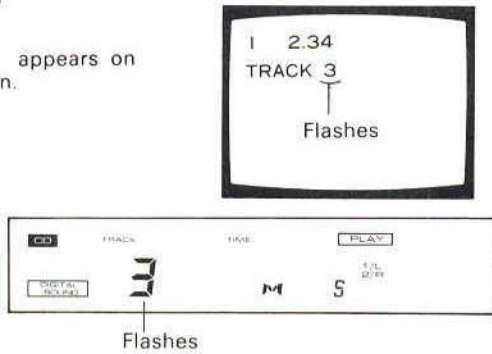

**2. Press the TRACK/TIME key**

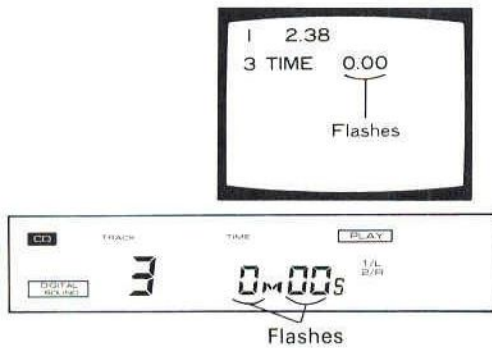

**3. Press 1, 2, 3**

■ Specifies 1 minute and 23 seconds into the 3rd track.

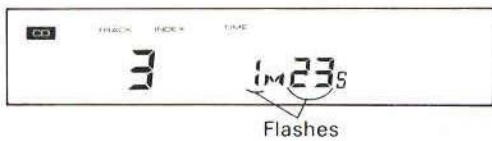

**4. Press the SEARCH/MEMORY key**

The player searches for the point 1 minute and 23 seconds from the start of Track 3, and then begins playback.

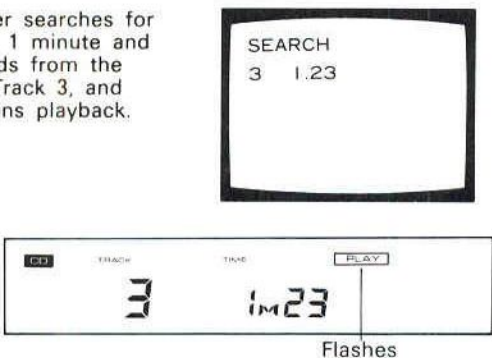

If neither the TIME DISPLAY button on the player nor the DISPLAY key on the remote control unit is pressed before a track search or time search is started, the on-screen display will go out following the search.

**When the TRACK/TIME key is pressed without prior entry of the track number, the track being played back is selected.**

If the specified search time is longer than the length of the track and the table of contents (TOC)\* can be correctly read, the player will not accept the search command.

If the disc is scratched so that the TOC cannot be read, the player searches for the start of the next track.

**Correcting the input number**

If the wrong number key was pressed, press the CLEAR key then enter the correct number.

**Ending a search**

Pressing the CLEAR key during search key input will set the search number to 0. Pressing the CLEAR key again at this point cancels the search number entry. Pressing the CLEAR key while the player is actually searching for a chapter or time ends the search and the player plays from disc wherever it was when the search was ended.

**Beginning play with a track search (Direct track start)**

Setting a disc on the disc table then entering a track search starts the disc playing from the specified track.

# REPEAT PLAYBACK

This function allows playback of part or all of a disc. Do this using the remote control unit.

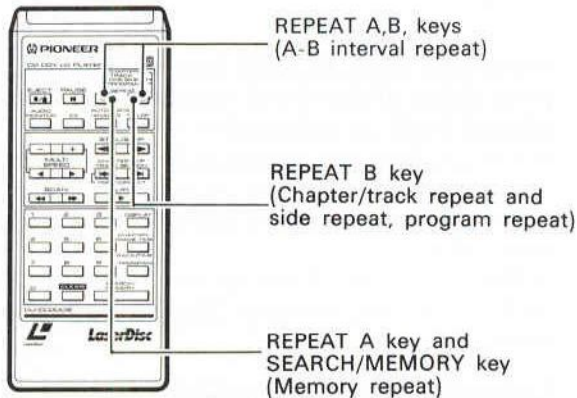

## FOR LASERVISION DISCS: REPEAT INTERVALS FOR EXTENDED PLAY DISCS

In the case of extended play discs, repeat playback is carried out using time numbers recorded on the disc. On some discs, time numbers are recorded with seconds as the minimum units, while on other discs, time numbers are recorded with minutes as the minimum units.

When A-B repeat or memory repeat are carried out with extended play discs on which time numbers are recorded with seconds as the minimum units, the point (scene) at which the key is pressed, and the actual repeat interval or search point (scene), corresponds almost exactly, but in the case of discs on which time numbers are recorded with minutes as the minimum units, these points do not always correspond.

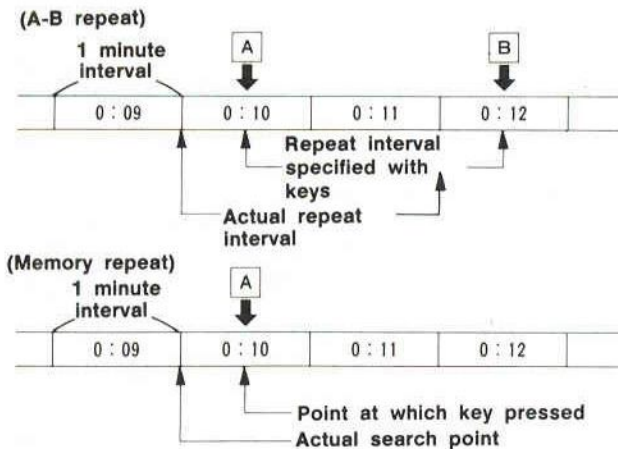

**NOTE:**

In the case of discs on which time numbers are recorded in minute units, the minimum A-B repeat interval is one minute. Also if the [A] and [B] repeat keys are pressed within the same "minute", A-B repeat is not performed.

## REPEAT PLAYBACK BETWEEN TWO POINTS (A-B)

This function repeatedly plays back an interval between specified frames (standard play disc) or between specified times (extended play discs).

**[Procedure]**

1. At the beginning point of the interval you wish to repeat, press the repeat (A) key.
2. At the end point of the interval you wish to repeat, press the repeat (B) key.

The A-B REPEAT indicator on the front panel of the player will light, and the interval between A and B will be repeatedly played back.

**[Display]**

(LaserVision Disc: Standard play disc)

(When the A key is pressed.)

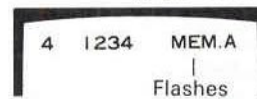

(When the B key is pressed.)

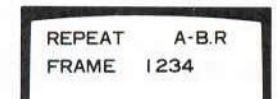

(Compact Disc or Audio portion of Compact Disc with Video)

(When the A key is pressed.)

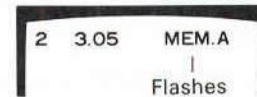

(When the B key is pressed.)

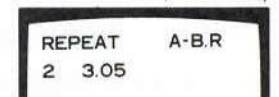

<Displays during search>

(LD) ● CAV	LD CHAP	FRAME	PLAY	REPEAT
			1/L 2/R	A-B
		1234		
				Flashes
(CD)	CD	TRACK	TIME	PLAY
				1/L 2/R
		2	3:05	
				Flashes
(CDV) Video portion	CDV	TRACK	TIME	PLAY
				1/L 2/R
			2:05	
				Flashes

**NOTE:**

- If you press the (A) key and then return to an earlier point in the program and press the (B) key (B < A), the player will repeat the interval between B and A, using B as the starting point and A as the ending point.
- When the chapter and frame or time is being displayed for a LaserVision Disc, pressing the A key makes the "MEM. A" display blink. Pressing the B key displays "A-B.R" continuously.
- Repeat play of a Compact Disc with Video cannot be performed for A and B points which extend over both audio and video portions.



**SIDE REPEAT**

One side of a disc is played back repeatedly. For Compact Discs with Video, playback is repeated for both the audio and video portions.

**[Procedure]**

Press REPEAT (B) in chapter/track repeat mode.

Accordingly, if you are playing back a disc on which chapter (or track) numbers are recorded, and are not already in chapter/track repeat mode, you should press REPEAT (B) twice in succession.

The ONE-SIDE REPEAT indicator on the front panel will light, and the CHAP./TRK.REPEAT indicator will go out.

After playing back to the end of one side of the disc, the player searches for the start of the disc, and plays the disc again.

**[Display]**

(LaserVision Disc: Standard play disc)

(When the B key is pressed to set the player for the side repeat mode.) (Search the beginning of the disc)



(Compact Disc)

(When the B key is pressed to set the player for the side repeat mode.) (Search the beginning of the disc)



<Displays during search>

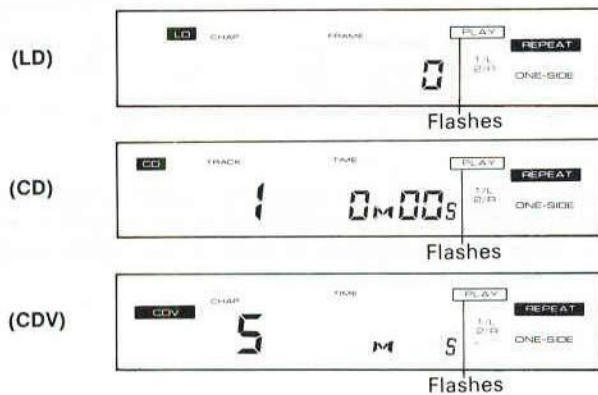

**NOTE:**

- When the CHAPTER/FRAME-TIME display is made with LaserVision Disc, the CHP.R and SID.R indicators also light continuously.

**PROGRAM REPEAT**

Pressing the REPEAT (B) key while the player is playing a chapter program puts the player in program repeat mode. Pressing the PLAY key starts repeat playback of the chapter program.

For more details, see Page 38 "Program Playback".

**TO CANCEL THE REPEAT MODE**

To cancel the repeat mode, press the CLEAR key.

● **During A-B repeat...**

After playing up to point B, the player advances to the next frame number or time number without returning to point A.

● **During chapter/track repeat...**

After playing to the end of the chapter (or track) currently being repeated, the player advances to the next chapter (or track).

● **During side repeat...**

After playing to the end of the disc, playback ends, and the disc stops rotating. When a Compact Disc with Video plays to the end of the video portion, play continues through the audio portion also. After the audio portion has played to the end, playback is completed.

● **During a program repeat...**

The last chapter or track in the program is played, then the play stops.

**SELECTION OF REPEAT MODE WITH THE REPEAT KEY**

The repeat mode selections which can be made using the REPEAT (B) key, are shown in the figure below. Please make use of this for specifying and changing the repeat mode.

**[Repeat mode selections using the REPEAT (B) key]**

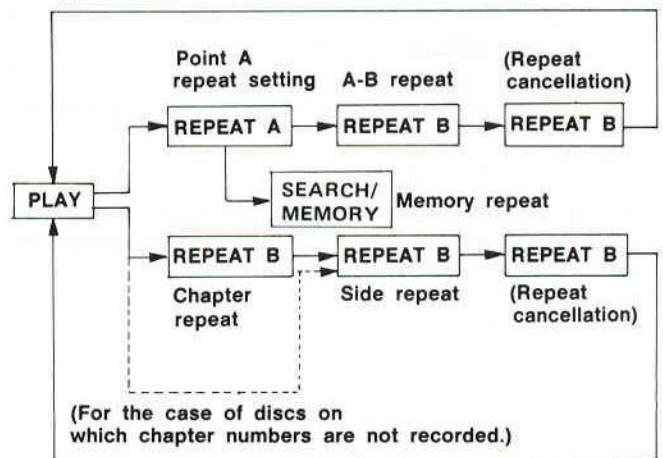

(For the case of discs on which chapter numbers are not recorded.)

### SWITCHING THE PLAYBACK MODE DURING REPEAT PLAY

Even during repeat play, remote control operations such as changes in the playback mode or searches are accepted. Some of these operations end the repeat play and some do not.

	LaserVision Disc, Video portions of CDV	Compact Disc, Audio portion of CDV
Do not cancel repeat play	<ul style="list-style-type: none"> <li>● Play</li> <li>● Pause</li> <li>● Still/Step (forward or reverse)</li> <li>● Multi-speed forward ( ▶ )</li> <li>● Fast forward, fast backward</li> </ul>	<ul style="list-style-type: none"> <li>● Play</li> <li>● Pause</li> <li>● Fast forward, fast backward</li> </ul>
Cancel repeat play	<ul style="list-style-type: none"> <li>● Chapter skip (forward or reverse)</li> <li>● Search operations (chapter/frame, time, number entry)</li> <li>● Program play</li> <li>● Multi-speed reverse ( ◀ )</li> <li>See note.</li> </ul>	<ul style="list-style-type: none"> <li>● Track search</li> <li>● Search operations (time or number entry)</li> <li>● Program play</li> </ul>

Note: Side repeat is not canceled.

# PROGRAM PLAYBACK

## CHAPTER PROGRAM PLAY

[LASERVISION DISC]

(Only discs on which chapter numbers are recorded)

## TRACK PROGRAM PLAY

[COMPACT DISC or COMPACT DISC WITH VIDEO]

This function lets you play back chapters on LaserVision Discs or tracks on Compact Discs or Compact Discs with Video, in any order you like. You can program the order you want using the remote control unit.

Chapter programming is not possible for LaserVision Discs in which chapter numbers are not recorded.

**NOTE:**

- Programming is possible during play, pause and repeat modes, but programming during repeat mode causes repeat mode to be cancelled.
- In the case of standard play LaserVision (CAV) Discs, programming can be done during still frame, and multi-speed playback also.

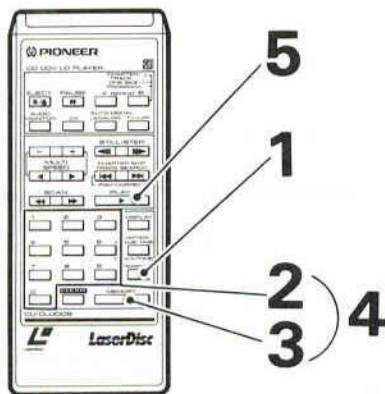

### [Program Playback Procedure]

A maximum of 20 steps can be programmed. The programmed chapter or track numbers are displayed on the screen in order. Attempts to program more than 20 items are not accepted.

<b>Procedure</b>	
<b>STEP 1.....</b>	<b>Press the PROGRAM key.</b>
<b>STEP 2.....</b>	<b>Enter a chapter or track number using DIGIT keys 0 - 9.</b>
<b>STEP 3.....</b>	<b>Press the SEARCH/MEMORY key.</b>
<b>STEP 4.....</b>	<b>If required, repeat steps 2 and 3.</b>
<b>STEP 5.....</b>	<b>Press the PLAY key.</b>

- Playback is in the programmed order.
- When all the programmed steps have been played, the player sets to the stop mode and the programs are cleared. The player then sets to the condition shown in step 1.

**[Example] To program playback of chapters 3, 6, and 1, in that order**

**1. PROGRAM**

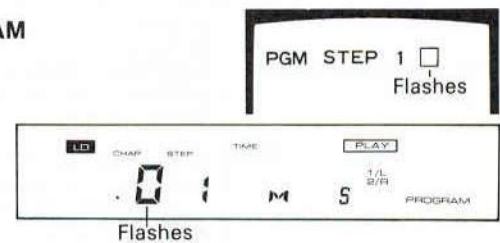

**2. 3, SEARCH/MEMORY**

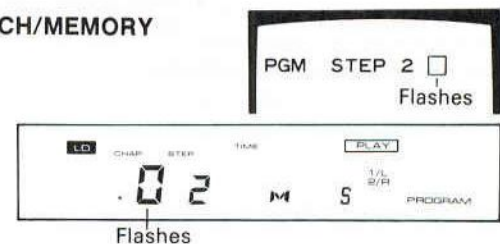

**3. 6, SEARCH/MEMORY**

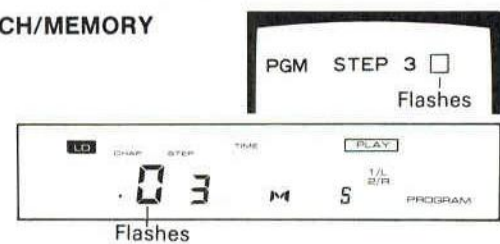

**4. 1, SEARCH/MEMORY**

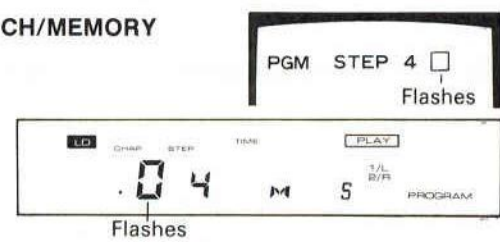

**5. PLAY .... Start of program play.**

**NOTE:**

- If chapter or track numbers not on the disc are entered.
  - LaserVision Discs without a table of contents : Chapter numbers not on the disc are programmed, but are skipped during program playback.
  - Compact Discs, Compact Discs with Video and LaserVision Discs with table of contents : If the table of contents has been read after playback starts, track numbers (chapter numbers) which are not on the disc cannot be programmed. However, with LaserVision Discs featuring a table of contents, chapter no. '0' is programmed even when it is not on the disc. If programming was performed before playback, entry of track numbers not on the disc will be accepted, but when playback starts, the selection numbers will be eliminated from the program when the table of contents is read.

### PAUSE PROGRAM

In place of a chapter or track number, it is possible to program a pause. When this is done, a "P" is displayed on the TV screen.

When recording on both sides of a cassette tape, programming for a pause to occur after the completion of the last track, before the first side of the tape runs out, will enable recording of the next track to begin, after the tape has been turned over.

[Example]

Program Compact Disc playback so that the player plays Track 3, pause, and Track 5.

Press PROGRAM, 3, SEARCH/MEMORY, PAUSE, SEARCH/MEMORY, 5, SEARCH/MEMORY and PLAY.

The player will then play Track 3, and search for and pause at the beginning of Track 5. When the PLAY key is pressed, playback of Track 5 will begin.

If a pause is programmed during the last step, the player will play back the chapter or track specified for the previous step, and then pause at the beginning of the next track or chapter.

### CORRECTION OF NUMERIC ENTRIES

To correct all the numbers that have been entered, press the PROGRAM key and then re-enter the numbers. To correct the number for the current step, press the CLEAR key and then enter the correct number.

### PROGRAM CORRECT

[Changing data during program input]

The data input during programming can be corrected using the SKIP buttons [▶▶], [◀◀] or PGM CORRECT keys [▶▶], [◀◀].

For example, [PROGRAM] [3] [SEARCH/MEMORY] [5] [SEARCH/MEMORY] [7] [SEARCH/MEMORY] and you wish to change the data input in second step to "2":

When the display indicates :



Press the ◀◀ key.



Press the ◀◀ key again.



Press number "2".



Press the SEARCH/MEMORY key.



Using the above procedure, the second programmed step number is changed to "2". If you press the play key at this point, the programs will be played in the order of "3", "2" and "7".

If you press the ▶▶ key in the same manner during program input, each time you press the key, the number for the step being correct will increase by one each time you press the key.

### [Changing the programming during program playing]

After pressing the PROGRAM key during program playing, press the PGM CORRECT keys [◀◀], [▶▶]. These serve as the program correct keys to change or add selections to the existing program. For example, if you wish to change "7" input in the 3rd step to "1" and add "8" as the 4th step...

Press the PROGRAM key.

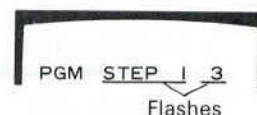

With the step presently being input, the indicator will flash to indicate that the data for that step cannot be changed.

In this example, it indicates that the "3" which is the selection input in step 1 is being played.

Press the ▶▶ key



Press the ▶▶ key once again



Press the no. "1" key.

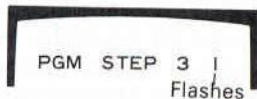

Press the SEARCH/MEMORY key.

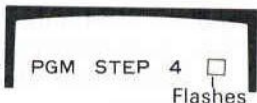

Press no. "8" key.



Press the SEARCH/MEMORY key.



After the desired corrections are made, press the PROGRAM key to register the corrections.

**PROGRAM PLAYBACK FROM STOP MODE**

If the player is programmed when the disc is not turning, or when the disc table is out, playback can start with program playback.

[Example]

Setting a LaserVision Disc on the disc table, then entering:

PROGRAM, 3, SEARCH/MEMORY, 1, SEARCH/MEMORY, PLAY retracts the disc table into the player and plays Chapter 3, then Chapter 1.

**PROGRAM DISPLAY**

[While program playing]

During playback with LaserVision Discs, when CHAPTER/FRAME·TIME display is called up, the program is displayed at the same time.

During playback of Compact Discs, the track number, the playing time and the program are displayed simultaneously.

(LaserVision Disc)

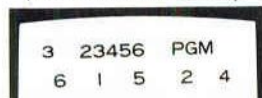

(Compact Disc)

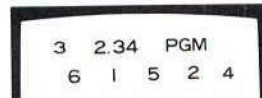

- The number indications on the display goes out when the corresponding program is finished.

NOTE:

**Display of playback information during track program play**

During program play of Compact Discs, the REMAIN and TOTAL displays show the time remaining for the program or the total number of tracks and the total playing time for the program.

- If a pause is programmed, the pause is not included in the TOTAL track number display.
- If the REMAIN or TOTAL time exceeds 99 minutes and 59 seconds, the minutes are displayed in 3 digits on the TV screen.
- In case of discs with more than 19 tracks, only the present time and track number are displayed (the time remaining on the program, the total number of tracks and the total playing time are not displayed).
- LaserVision Discs and the video portion of Compact Discs with Video do not display the remaining time. The TOTAL display indicates only the total number of tracks and total playing time of the disc.

NOTE:

If more than 19 tracks are recorded on the disc, this display will not be appear.

**PROGRAM REPEAT PLAYBACK**

When the REPEAT B key is pressed during programmed playback, the programmed playback will be repeated. The REPEAT and PROGRAM indicators on the player's front panel will also light.

To cancel repeat playback, press either the CLEAR key or the REPEAT B key.

Example: (for LaserVision Discs)

Press the REPEAT (B) key during programmed playback.

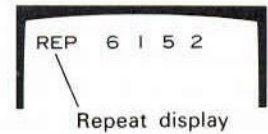

When setting to programmed playback with the PLAY key, the program will be repeated.

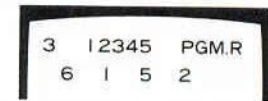

**SKIPPING OF PROGRAM STEPS**

If the CHAPTER SKIP/TRACK SEARCH key is pressed during program playback, a program step can be skipped.

[Example]

Let us assume 3, 6, 1, 5, and 2 have been programmed for a LaserVision Disc, and that playback is in progress.

- During playback of Chapter 1 (step 3) the ►► side of the CHAPTER SKIP key is pressed. → The player will skip to the beginning of Chapter 5 (step 4).
- During playback of Chapter 1 (step 3) the ◀◀ side of the CHAPTER SKIP key is pressed. → The player will skip to the beginning of Chapter 1 (step 3).

If the key is repeatedly pressed, steps will be skipped accordingly.

If a pause is programmed, the skip operation will ignore the pause, and will skip to the following (or preceding) step.

**CANCELLATION OF PROGRAM PLAYBACK**

When all of the programmed chapters or tracks have been played back, the disc stops rotating, and the program is cleared.

To cancel playback part way through program playback, press the CLEAR key. (This will also cause the program to be cleared.)

NOTE:

- If search, or repeat operations are performed during program playback, the program playback will be cancelled.
- During playback of a standard play (CAV) LaserVision Disc, program playback will be cancelled if multi-speed operation in the reverse direction (◀) is carried out.
- Programming can be performed during play, stop, pause or repeat playback. However, when programming is performed in the repeat playback mode, the repeat mode will be canceled.
- If a chapter number which is not on the disc is programmed, the number will be skipped during program playback.



# TROUBLESHOOTING

Incorrect operations are often mistaken for trouble and malfunctions. If you think that there is something wrong with this component, check the points below. Sometimes the trouble may lie in another component. Investigate the other components and electrical appliances being used.

If the trouble cannot be rectified even after executing the checks listed below, ask your nearest PIONEER authorized service center or your dealer to carry out repair work.

SYMPTOM	CAUSE	REMEDY
1 Disc table is not expelled when EJECT button is pressed.	<ul style="list-style-type: none"> <li>• Power cord is not properly plugged into AC wall socket.</li> <li>• Power switch is not turned on.</li> </ul>	<ul style="list-style-type: none"> <li>• Plug in power cord.</li> <li>• Turn on power switch.</li> </ul>
2 Disc table comes out.	<ul style="list-style-type: none"> <li>• Disc is dirty.</li> <li>• Moisture has condensed on parts in the player.</li> <li>• Disc is warped.</li> </ul>	<ul style="list-style-type: none"> <li>• Refer to instructions under "Remedy", item 9, and clean disc.</li> <li>• Remove disc and let player stand for 1 to 2 hours until it is dry.</li> <li>• Correct the disc. (Refer to Symptom 9, remedy column.)</li> </ul>
3 TV no longer receives other channels after it has been connected to the player.	<ul style="list-style-type: none"> <li>• Antenna cable has not been connected.</li> <li>• TV indicator does not light.</li> </ul>	<ul style="list-style-type: none"> <li>• Connect VHF antenna cable to antenna terminal on the player.</li> <li>• Press the TV/LDP key on the remote control unit to turn the indicator on, or turn off the player's power switch.</li> </ul>
4 Slanting stripes appear on the TV screen when TV/LDP key is pressed to receive TV broadcasts.	<ul style="list-style-type: none"> <li>• Electric field for TV broadcasting is weak. (This does not indicate any trouble.)</li> </ul>	<ul style="list-style-type: none"> <li>• Turn off the power switch of the player. We recommend that you turn off the power switch of the player, whenever you intend to watch TV for a long time.</li> </ul>
5 Remote control does not work.	<ul style="list-style-type: none"> <li>• The control terminal on the back panel is used.</li> <li>• Remote control unit batteries are weak.</li> <li>• There is an obstacle between the player and the remote control unit.</li> <li>• Remote control unit is not in a good location for transmission.</li> </ul>	<ul style="list-style-type: none"> <li>• Remove the connector plug.</li> <li>• Replace batteries.</li> <li>• Remove the obstacle or shift the remote control position.</li> <li>• Operate the remote control unit in front of the player.</li> </ul>
6 Operation of the remote control unit causes the TV to operate improperly.	<ul style="list-style-type: none"> <li>• Some TV sets have remote control functions that operate improperly in response to the remote control unit of the player.</li> </ul>	<ul style="list-style-type: none"> <li>• Move the TV and the player further apart, or cover the remote sensor of the TV during disc playback.</li> </ul>

WHEN A LASERVISION DISC IS BEING PLAYED

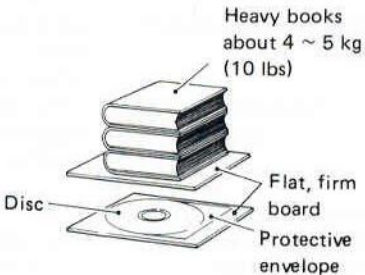
SYMPTOM	CAUSE	REMEDY
<p>7 Disc rotates but there is no picture.</p>	<ul style="list-style-type: none"> <li>● The TV set is not turned on.</li> <li>● Wrong connections from player to TV.</li> <li>● TV set is not turned to channel 3 or 4.</li>   <li>● Player CHANNEL SELECTOR is at the wrong setting.</li> <li>● The television is not properly tuned.</li>   <li>● TV indicator is lit.</li> </ul>	<ul style="list-style-type: none"> <li>● Turn on TV.</li> <li>● Make correct connections.</li> <li>● Set TV to the channel (3 or 4) that is not used for TV broadcasting in your area.</li> <li>● Set selector to same channel as the TV's empty channel.</li> <li>● Tune the television properly. (Refer to the User's Manual for the television.)</li> <li>● Press the TV/LDP key on the remote control unit so that the TV indicator turns off.</li> </ul>
<p>8 Picture continuously moves vertically</p>	<ul style="list-style-type: none"> <li>● The TV vertical hold control is not adjusted properly.</li> </ul>	<ul style="list-style-type: none"> <li>● Adjust vertical-hold control on TV.</li> </ul>
<p>9 Particular disc does not play back properly. The playback stopped in the middle of the disc program.</p>	<ul style="list-style-type: none"> <li>● The playing surface of the disc is dirty.</li>   <li>● The disc is warped.</li> </ul>	<ul style="list-style-type: none"> <li>● Use a soft cloth and lightly wipe off the dirt from the surface of the disc. If necessary, moisten a cloth with diluted neutral detergent to remove heavy dirt or fingerprints.</li> <li>● Put the disc into the protective envelope, then place it on a flat desk top. Subsequently, place a flat board on the disc, and load it with weights of about 4 ~ 5 kgs (about 10 lbs). If it is left in this state for one day, sometimes the warp will be alleviated.</li> </ul> <div style="text-align: center;">  <p>Heavy books about 4 ~ 5 kg (10 lbs)</p> <p>Flat, firm board</p> <p>Protective envelope</p> <p>Disc</p> </div>
<p>10 Sound is unnatural or distorted.</p>	<ul style="list-style-type: none"> <li>● CX system is turned ON for disc which has no "CX" mark.</li> </ul>	<ul style="list-style-type: none"> <li>● Press CX key (on remote control unit) to turn CX system OFF.</li> </ul>
<p>11 No sound output during playback.</p>	<ul style="list-style-type: none"> <li>● MULTI-SPEED playback is being performed.</li> <li>● Sound is output only during the normal play mode. The audio channels are not put out during other playback modes.</li> </ul>	<ul style="list-style-type: none"> <li>● Press the PLAY/PAUSE button or the PLAY key of the remote control unit.</li> </ul>

SYMPTOM	CAUSE	REMEDY
12 Special effects play cannot be performed.	<ul style="list-style-type: none"> <li>Playing back an extended play disc.</li> </ul>	<ul style="list-style-type: none"> <li>With extended play disc, special effects playback, such as STILL/STEP, MULTI-SPEED cannot be performed.</li> </ul>
13 During STILL playback, a part of the screen shakes.	_____	<ul style="list-style-type: none"> <li>Even if the disc is a standard play disc, there may be some cases in which a fully still image cannot be obtained, but this does not mean that the player or the disc is defective.</li> </ul>
14 CHAPTER SKIP, CHAPTER PROGRAM PLAY and CHAPTER NUMBER SEARCH cannot be performed.	<ul style="list-style-type: none"> <li>Disc in which no chapter numbers are recorded is loaded.</li> </ul>	<ul style="list-style-type: none"> <li>Press DISPLAY key to check if chapter number is displayed.</li> </ul>
15 A considerable length of time is required for searching before playback begins.	<ul style="list-style-type: none"> <li>It takes time to read the recorded code, depending on the disc.</li> </ul>	<ul style="list-style-type: none"> <li>Press CLEAR key and picture will appear. (At this point, a scene slightly different from that which has been searched for may appear.)</li> </ul>
16 The player takes too long to find point A during A - B (INTERVAL) REPEAT operation.	<ul style="list-style-type: none"> <li>Same as item 15 above.</li> </ul>	<ul style="list-style-type: none"> <li>Same as item 15 above (The repeat mode is cancelled).</li> </ul>
17 Picture other than that instructed is searched in TIME NUMBER SEARCH mode.	<ul style="list-style-type: none"> <li>Method of inputting numerals in the TIME NUMBER SEARCH mode differs, depending on whether time number is recorded on disc in minutes or seconds, as shown below: [e.g.] 12-minute search</li> <li>Disc in which time number is recorded in minutes</li> </ul> <div style="text-align: center;"> </div> <ul style="list-style-type: none"> <li>Disc in which time number is recorded in seconds</li> </ul> <div style="text-align: center;"> </div>	

## WHEN PLAYING BACK A COMPACT DISC

SYMPTOM	CAUSE	REMEDY
<b>18 Player stops immediately after starting playback.</b>	<ul style="list-style-type: none"> <li>● Disc is loaded upside down.</li> <li>● The playing surface of the disc is dirty.</li> <li>● Disc is not properly loaded on the disc table.</li> </ul>	<ul style="list-style-type: none"> <li>● Load the disc correctly with the label side upward.</li> <li>● Use a soft cloth and lightly wipe off the dirt from the surface of the disc. If necessary, moisten a cloth with diluted neutral detergent to remove heavy dirt or fingerprints.</li> <li>● Reload the disc.</li> </ul>
<b>19 No sound output</b>	<ul style="list-style-type: none"> <li>● The stereo amplifier is not correctly connected.</li> <li>● You are not operating the stereo amplifier correctly.</li> <li>● The connection terminals and/or the plugs of the connection cords are dirty.</li> <li>● The plugs of the connection cords are disconnected, or are not fully pushed in.</li> <li>● You have connected the amplifier to the player ANALOG AUDIO OUT terminals.</li> <li>● The player is in PAUSE mode.</li> </ul>	<ul style="list-style-type: none"> <li>● Connect the amplifier correctly.</li> <li>● Refer to the operating instructions for the amplifier, and operate the amplifier correctly.</li> <li>● Clean the plugs and terminals and connect again.</li> <li>● Make sure that connections are correct.</li> <li>● Connect the amplifier to the DIGITAL/ANALOG AUDIO OUT terminals. (The ANALOG AUDIO OUT terminals, do not provide audio output for Compact Disc playback.)</li> <li>● Press the PLAY key and restore the player to PLAY mode.</li> </ul>
<b>20 Sound is distorted</b>	<ul style="list-style-type: none"> <li>● The stereo amplifier is not correctly connected.</li> <li>● The connection terminals and/or the plugs of the connection cords are dirty.</li> <li>● The plugs of the connection cords are not fully pushed in.</li> <li>● The playing surface of the disc is dirty.</li> </ul>	<ul style="list-style-type: none"> <li>● Connect the DIGITAL/ANALOG AUDIO OUT terminals of the player, to the CD or AUX input terminals etc. of the amplifier. (Do not connect to the PHONO input terminals of the amplifier.)</li> <li>● Clean the plugs and terminals and connect again.</li> <li>● Push the plug in firmly.</li> <li>● Use a soft cloth and lightly wipe off the dirt from the surface of the disc. If necessary, moisten a cloth with diluted neutral detergent to remove heavy dirt or fingerprints.</li> </ul>

# SPECIFICATIONS

## 1. General

System .....	LaserVision Disc system and Compact Disc digital audio system
Laser .....	Semiconductor laser wavelength 780 nm
Power requirements	
U.S. and Canadian models.....	AC 120 V, 50/60 Hz
Power consumption	
U.S. and Canadian models.....	38 W
Weight .....	9.2 kg (20 lb 4 oz)
Dimensions.....	420(W) x 438(D) x 110(H) mm 16-9/16(W) x 17-1/4(D) x 4-5/16(H) in
Operating temperature .....	+5 °C — +35 °C (41°F — 95°F)
Operating humidity .....	5% — 90% (There should be no condensation of moisture.)

## 2. Disc

### LaserVision Discs

*Maximum playing times	
12-inch standard play disc.....	1 hour/both sides
12-inch extended play disc.....	2 hours/both sides
8-inch standard play disc.....	28 min/both sides
8-inch extended play disc.....	40 min/both sides
Spindle motor speed	
Standard play disc.....	1,800 rpm
Extended play disc	
.....	1,800 rpm (inner circumference) to 600 rpm (outer circumference) (For a 12-inch disc)

### Compact Discs

Disc.....	Diameter: 5-inch, 3-inch, Thickness: 1.2 mm
Rotation direction (pickup side):	Counterclockwise
Linear speed:	1.2 — 1.4 m/sec
*Maximum playing time	
60 min. or more:	5-inch discs
20 min. or more:	3-inch discs
(For stereo playback)	

### Compact Discs with Video

Disc.....	Diameter: 5-inch, Thickness: 1.2mm
Rotation direction (pickup side).....	Counterclockwise
Linear speed .....	Audio portion : 1.2 — 1.4m/sec Video portion: 11 — 12 m/sec
Maximum playing time.....	Video portion: 5 min. (CLV) Audio portion: 20 min.(Digital)

\*Actual playback time differs for each disc.

## 3. Video characteristics

Format.....	NTSC specifications
Video output	
Level...1 Vp-p nominal, sync. negative, terminated	
Impedance.....	75 Ω unbalanced
Terminal.....	RCA jack
VHF output	
Channel .....	Channel 3 or 4 (switchable)
Impedance.....	75 Ω unbalanced
Terminal .....	F-type jack

## 4. Audio characteristics

Output level	
DIGITAL/ANALOG OUT terminals	
During analog audio output.....	200 mVrms (1kHz, 40%)
During digital audio output.....	200 mVrms (1kHz, -20dB)
ANALOG OUT terminals.....	200 mVrms (1kHz, 40%)
Terminal .....	Both RCA jacks
Number of channels .....	2

### Digital Audio Characteristics

Frequency response	4 Hz - 20 kHz ( $\pm 0.5$ / $-1.0$ dB) (EIAJ)
S/N ratio	98 dB (EIAJ)
Dynamic range	95 dB (EIAJ)
Channel separation	92 dB (EIAJ)
Total harmonic distortion	0.005% (EIAJ)
Wow and flutter	Limit of measurement (±0.001% W.PEAK) or less (EIAJ)

● LD is based on EIAJ.

## 5. Other Terminals

Control input/output.....	Both miniature jacks
Headphones.....	Standard stereo jack

## 6. Accessories

Remote control unit (CU-CLD009) .....	1
Size "AAA" (IEC R03) dry cell battery .....	2
RF antenna cable .....	1
Video connecting cord.....	1
Audio connecting cord.....	1
Antenna adaptor	
(75 Ω/300 Ω → 75 Ω F-type plug) .....	1
Operating instructions.....	1
Warranty card .....	1

SPECIFICATIONS

**7. Functions**

Function that can be operated with remote control unit (CU-CLD009)

Functions	LaserVision Disc		Compact Disc	Compact Disc with Video
	Standard Play Disc	Extended Play Disc		
PLAY	YES	YES	YES	YES
EJECT	YES	YES	YES	YES
TV/LDP SELECTION	YES	YES	YES	YES
PAUSE	YES	YES	YES	YES
SCAN (Forward, Reverse)	YES	YES	YES	YES
AUDIO CHANNEL SELECTION (Stereo, 1/L, 2/R)	YES	YES	YES	YES
AUTO DIGITAL/ANALOG SWITCH	YES(1)	YES(1)	—	—
CX SYSTEM ON/OFF	YES(2)	YES(2)	—	—
STILL/STEP (Forward, Reverse)	YES	NO	—	NO
CHAPTER SKIP (Forward, Reverse)	YES(3)	YES(3)	—	—
MULTI-SPEED (Forward, Reverse: variable in 9 steps)	YES	NO	—	NO
MULTI-SPEED DISPLAY	YES	NO	—	NO
CHAPTER/FRAME NUMBER DISPLAY	YES	NO	—	—
CHAPTER/TIME NUMBER DISPLAY	NO	YES	—	—
FRAME NUMBER SEARCH	YES	NO	—	—
TIME NUMBER SEARCH	NO	YES	—	—
CHAPTER NUMBER SEARCH	YES(3)	YES(3)	—	—
CHAPTER REPEAT	YES(3)	YES(3)	—	—
A-B (INTERVAL) REPEAT	YES	YES	YES	YES
MEMORY REPEAT	YES	YES	YES	YES
SIDE REPEAT	YES	YES	YES	YES
PROGRAM PLAYBACK	YES(3)	YES(3)	YES	YES
PROGRAM DISPLAY	YES(3)	YES(3)	YES	YES
PROGRAM REPEAT	YES(3)	YES(3)	YES	YES
PROGRAM CORRECT	YES(3)	YES(3)	YES	YES
TRACK SEARCH (SKIP SELECTION)	—	—	YES	YES
TIME SEARCH	—	—	YES	YES
TRACK REPEAT	—	—	YES	YES
TRACK NUMBER SEARCH (DIRECT SELECTION)	—	—	YES	YES
TRACK.TIME DISPLAY	—	—	YES	YES
REMAINING TIME DISPLAY	—	—	YES	YES(4)
TOTAL TRACKS.TOTAL TIME DISPLAY	YES(5)	YES(5)	YES	YES

**NOTE:**

- (1) Can only be used with discs with digital sound.
- (2) Valid for analog sound when playing a disc with the CX mark.
- (3) Possible for playback of disc on which chapter numbers are recorded.
- (4) Possible only for the audio portion of Compact Discs with Video.
- (5) Functions only during playback with discs featuring a table of contents.

**Other Functions**

- Automatic picture stop (Functions only for Laser-Vision Discs with a picture stop code recorded on them)
- Auto program editing
- Headphones level control, Random play (CD, CDV)

**NOTE:**

Specifications and design subject to possible modifications without notice, due to improvement.

LaserDisc is a trademark of Pioneer Electronic Corporation.

---

**PIONEER ELECTRONIC CORPORATION** 4-1, Meguro 1-Chome, Meguro-ku, Tokyo 153, Japan  
**PIONEER ELECTRONICS [USA] INC.** 2265 East 220th Street Long Beach, California 90810 U.S.A.  
P.O. BOX 1720 Long Beach, California 90801-1720 U.S.A.  
**PIONEER ELECTRONICS OF CANADA, INC.** 505 Cochrane Drive, Markham, Ontario L3R 8E3 Canada  
**PIONEER ELECTRONIC [EUROPE] N.V.** Keetberglaan 1, 2740 Beveren, Belgium TEL: 03/775-28-08  
**PIONEER ELECTRONICS AUSTRALIA PTY. LTD.** 178-184 Boundary Road, Braeside, Victoria 3195, Australia TEL: [03] 580-9911